



# Packaging solutions

to protect your products and...



...profits  
...the environment  
...brand  
...reputation  
...and more

**What will  
you protect?**

[macfarlanepackaging.com](http://macfarlanepackaging.com)



At Macfarlane Packaging we have the experience, scale and reach to meet all of your packaging needs.

We don't just mean our incredible product range. With our support we can ensure your packaging operation is affordable, flexible and sustainable.

This book will show you how we do it.











**About Macfarlane Packaging**

Sustainability	2
Customisation	6
Automation	7

<b>Index</b>	<b>135</b>
--------------	------------

<b>Contact us</b>	<b>140</b>
-------------------	------------

**Products**

Boxes	9	
Bags	21	
Postal	29	
Protective	43	
Paper	79	
Tapes	87	
Polythene	99	
Stretch	107	
Strapping	117	
Accessories	127	

# Helping you make an informed choice

The role of good packaging is to protect your products. If your packaging is doing its job, it will limit your impact on the environment.

We can help you with environmentally friendly packaging materials that reduce waste in your supply chain and lower your carbon emissions.



## The right pack

Good packaging must be carefully planned from the start to reduce waste and support sustainability. The ideal sustainable packaging provides maximum protection with minimal use of material.

We apply the 3Rs – **reduce, reuse, and recycle**, as part of our approach to packaging.



### Smaller footprint

The right choice of packaging materials and JIT delivery can eliminate waste, reducing your packaging footprint and saving space.



### Less CO<sub>2</sub>

Lighter, smaller packs mean pallet optimisation, which can reduce the number of journeys you take, reduce load weight and cut fuel use and emissions.

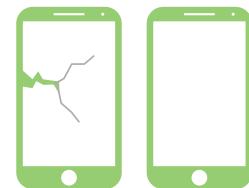

### Half the environmental cost

Better pack design reduces damages. Each time damaged goods are replaced the carbon cost of a transaction increases.

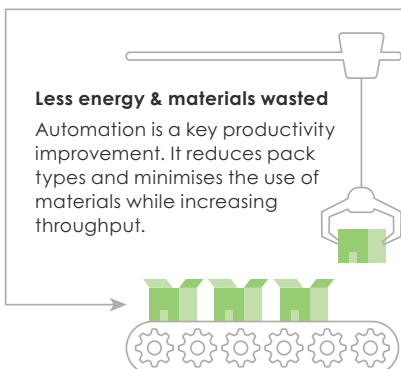

### Less energy & materials wasted

Automation is a key productivity improvement. It reduces pack types and minimises the use of materials while increasing throughput.



### Happier customers

Most of the packaging that can deliver these supply chain benefits is fully recyclable, made from recycled material or reusable, something more and more customers are demanding.





# The Macfarlane Packaging Steps to Sustainability

We know that eco-friendly packing materials can play a huge part in corporate and sustainability goals for businesses, with many looking to reduce packaging use and minimise material waste.

We can help you take your sustainability to the next level when it comes to packaging. Our approach will identify the impact packaging has on your operation and redress its impact throughout the supply chain.

## 1. Talk to us about your sustainability goals

We can help identify the key environmental costs in your packaging operation and help you reduce or eliminate them.

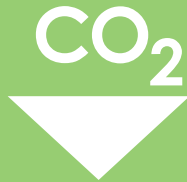

## 2. Identify sustainable packaging alternatives

We will recommend opportunities to reduce, reuse or recycle, and reduce material use.



## 3. Assess the knock-on effect of packaging

We will look at reductions in shipment weight, product damages and return rates. We'll help you reduce your fleet (or courier) carbon emissions.



## 4. Illustrate and report savings

We'll help you calculate and report reductions so that you can share the improvements with your customers and stakeholders.



Take the first step by contacting us today on: [0800 2888444](tel:08002888444)



## Environment policy

At Macfarlane Packaging, we are committed to reducing the impact of our activities on the environment.

Packaging is an essential commodity for most businesses and, used properly, can reduce waste by protecting products in transit.

### We are committed to helping you to:

- 1 Use the minimum amount of packaging material possible, eliminating where possible.
- 2 Deploy the most efficient packaging products available.
- 3 Re-use packaging materials wherever possible.
- 4 Use packaging that is reusable, recyclable or made from recycled material.

In these ways we seek to ensure that your products are fully protected while using packaging in a responsible way.



The mark of responsible forestry



RS 00090 EMS 516037



## The Macfarlane Packaging Environmental Impact Rating

The Environmental Impact Rating bar accompanies every product entry in this book. It is part of our commitment to helping you make informed choices about packaging and the environment. The guide on this page gives you a more detailed explanation of the symbols' meaning and origin.

### OPRL recycling logos

Macfarlane Packaging is a member of the OPRL (On-Pack Recycling Label) scheme. The scheme is UK wide and tells you how easily a labelled pack can be recycled in the UK.



#### Recycle

Applied to packaging collected by 75% or more of UK local authorities and then sorted, processed and recycled into new packaging or products.



#### Recycle with bags at large supermarkets | Don't recycle at home

Applied on plastic wrapping such as bread bags, fruit and veg bags, crisp packets and chocolate wrappers. You can recycle this type of packaging at recycling points in selected supermarkets.



#### Don't recycle

Applied to packaging collected by less than 50% of UK local authorities and/or is not able to be sorted, processed and recycled into new packaging or products.

### Recyclability category

International recycling code for materials



**Widely recycled - PET (Polythene Terephthalate)**



**Recyclable - HDPE (High Density Polyethylene)**



**Non recyclable - PVC (Polyvinyl Chloride)**



**Recyclable - LDPE (Low-Density Polyethylene)**



**Recyclable - PP (Polystyrene)**



**Non recyclable - PS (Polystyrene)**



**Non recyclable**



**Recyclable - PAP (Cardboard)**



**Recyclable - PAP (Paperboard)**



**Recyclable - PAP (Paper)**



**Recyclable - FE (Steel)**



**Recyclable - FOR (Wood waste)**

### Recycled content

Percentage of content that has come from recycled (not virgin) content.

Tolerance +/- 5%

All information is correct at the time this book is published. For updated information, visit our website or call us at 0800 2888 444

Local service with national coverage

Wide product range

Next day delivery available

Stock holding and call-off service



# Custom packaging

At Macfarlane Packaging, we can help you with all kinds of custom packaging. Whether you need a bespoke packaging solution to provide protection for high-value products or want to enhance your customer experience with branded packaging, our experts will be with you every step of the way...



Free Custom Packaging Estimates



Bespoke Packaging Sizes and Printing



Expert Packaging Design



Custom Packaging Quality Assurance



An intelligently designed pack can play a major role in reducing damages, increasing productivity, reducing your packaging waste, and controlling transport costs. Plus, packaging that reflects your brand can help you create a great impression on customers.

**Almost any type of packaging can be customised to your specifications – whether you need a specific size, design, or printing.**

**From boxes, bags and tape through to custom protective materials, chilled packaging and bespoke warehouse design, the Macfarlane team will be able to deliver the solution you need.**



Scan me to find out more

### Here's how custom packaging can benefit you:

- Protect your products more effectively
- Improve your customer experience
- Build brand awareness
- Make your packing operation more sustainable
- Reduce damages and returns
- Lower your shipping costs







# Packaging Automation

Transform your operation with packaging automation and packaging machinery.

Packaging automation systems are ideal for high demand packing environments where speed is key. If you're shipping a range of different shape products in significant volume, the right packaging machinery and processes can help you optimise your operation, cut costs and future-proof your production line for growth...



## Signs your operation could be ready for packaging automation

- Your packaging is increasingly taking up room in your warehouse
- You continually need to hire new staff for your production and/or packing line
- Your packs produced per hour aren't increasing in line with demand
- Your business is creating increasing levels of packaging waste
- You experience an uplift in customer complaints about damaged goods (if demand is too high, packing quality could be less reliable)
- Your team morale in packing areas may be lower due to increased workload

## How packaging automation can benefit your business

- Lower your packaging costs
- Improve pack line productivity
- Reduce your carbon footprint
- Enhance packing quality control
- Use less packaging materials
- Save on storage space
- Optimise transport usage
- Future proof for growth and seasonal demand

**Almost any packaging process can be automated from boxing, void filling, bagging, pallet wrapping and taping through to warehouse movement. There are semi and fully automated solutions available for a range of applications and businesses of different sizes. Contact the Macfarlane team to find out more...**



# Macfarlane Packaging protects...

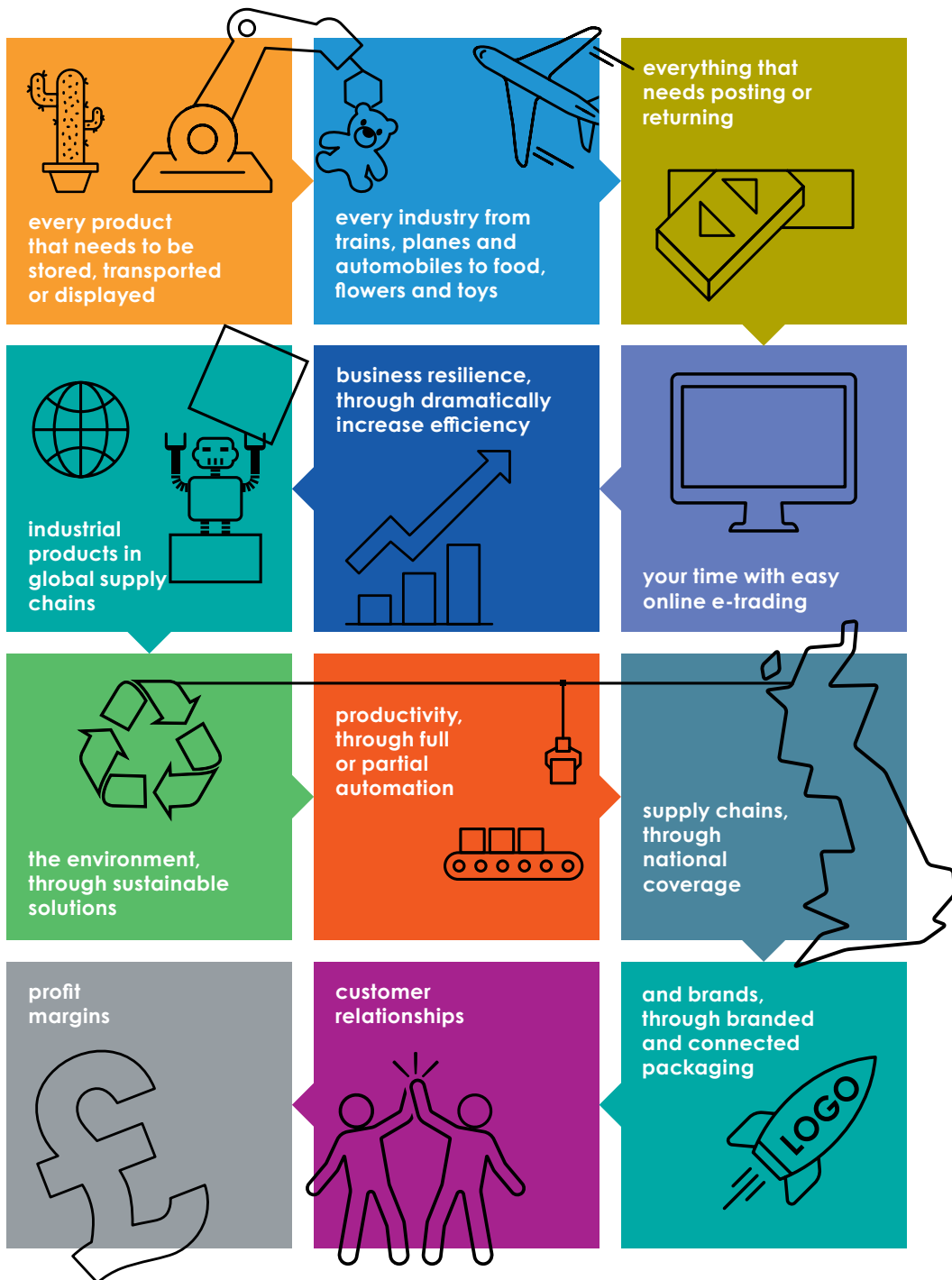

## What will you protect?



# Boxes

## Box information

How to measure a box	10
Popular FEFCO Styles	11

## Products

Single Wall Boxes	12
Double Wall Boxes	14
Euro Pallet Boxes	16
Palletised Container	16
BDCM Boxes	17
Pallets	17
Temperature Controlled Packaging	18



Boxes



Local service with national coverage

Wide product range

Next day delivery available

Stock holding and call-off service

# Box information

## How to measure a box

Dimensions are usually expressed as internal dimensions in mm as follows: Length (L) x Width (W) x Height (H).

Macfarlane Packaging has internal design and manufacturing capabilities and works with the leading international packaging manufacturers to provide the best and unbiased packaging solutions, at the most competitive prices.

**Length = The longer dimension at the opening**

**Width = The shorter dimension at the opening**

**Height = The dimension from the top of the opening to the base**

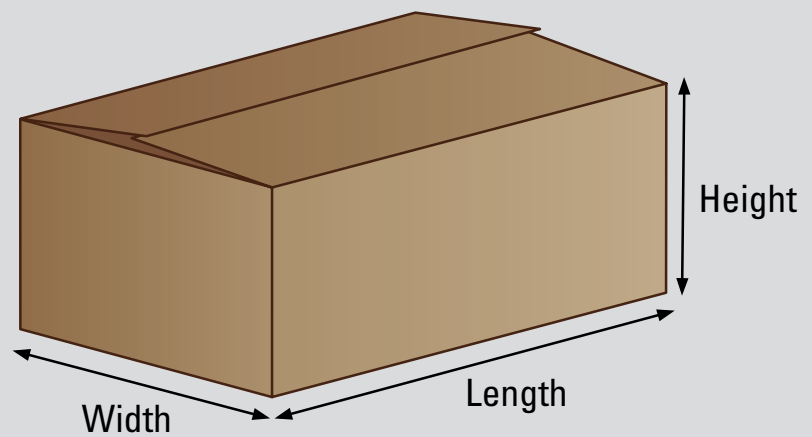





## Popular FEFCO Styles

FEFCO styles are International Fibreboard Case Codes: an internationally recognised methodical presentation of case design styles.

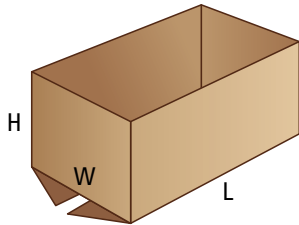

### 0200

An open top box with flaps meeting at the base, which need to be sealed. Often linked with the **0422** lid and used for storage.

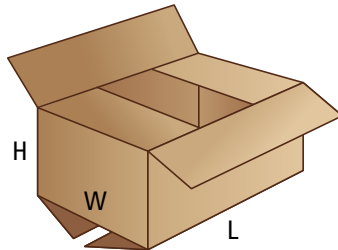

### 0201

The most common corrugated case. Outer flaps meet at the top and bottom and require sealing. It will not require any tooling unless it needs modification for specialist erecting machines. This is the most economical way to pack most products. The side seam is usually glued but can be stitched. Stacks well.

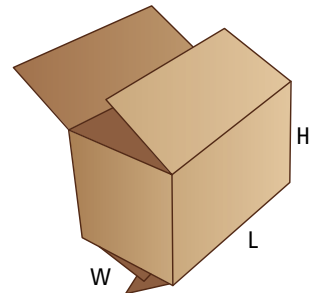

### 0202

Similar to **0201** but with the outer flaps overlapping by a specified amount. Ideal for cases where extra strength and security are needed. Excellent for use with polypropylene strapping as the method of securing.

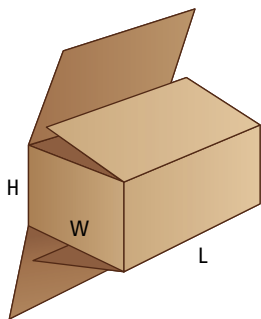

### 0203

Similar to the **0201** but the flaps fully cover the base and top. This gives added strength to the case especially if taped in certain ways.

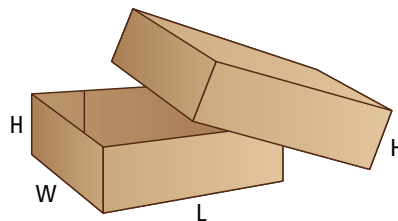

### 0301

Tray and lid. Used for shallow products and an economical way to purchase this format as it can be made without tooling. However, the corners of the lid and tray would need to be sealed. A neater solution would be the **0422**, particularly if the volume required is significant.

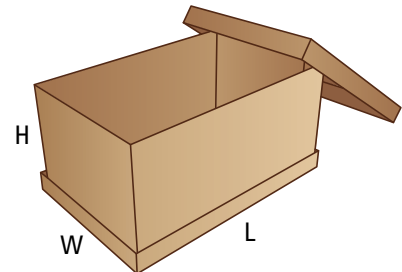

### 0310

A combination pack of **0501** sleeve with **0452** top and bottom caps (not featured). Generally used for pallet packs or with automated packing systems. Requires stitching or gluing of the caps.

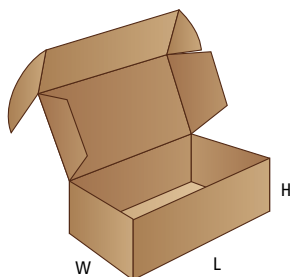

### 0427

Folder-type boxes and trays usually consist of only one piece of board. The bottom of the box is hinged to form two or all side walls and the cover.

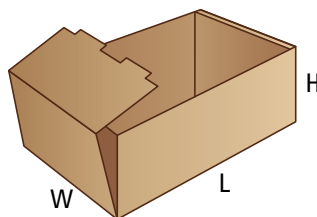

### 0422

Lid for **0200** or used as a tray. This will require a tool to make but is then easily erected without sealing.

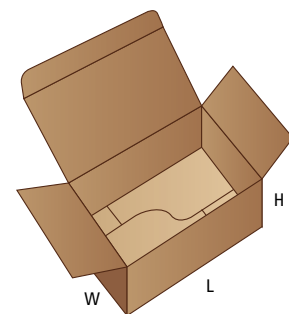

### 0713

Ready-glued cases consist of basically one piece, are shipped flat and ready to use by simple setting up.

# Boxes

## Single Wall Boxes

Storage for every demand

Single wall provides durable protection, using outer and inner liners reinforced by specially designed fluting for added strength.

Our corrugated packaging is made from natural, renewable sources.

Single wall boxes are available in over 40 sizes to meet every demand. Dimensions – measured internally for optimum fit – are shown in millimetres: as length x width x height.

Custom sizes and printing available

Call Us



The mark of responsible forestry

We can supply these boxes in FSC material.



Multi-depth case shown

Internal measurements ensure you make the right choice

Environmental impact rating See page 5



recycle



recyclability category  
FAP



minimum recycled content

don't forget...

SEE PAGE  
98  
Tape dispensers



SEE PAGE  
90  
Standard tape



SEE PAGE  
45  
Bubble wrap



SEE PAGE  
132  
Box corner safety cutter



## Single Wall Boxes

Product Code	Size L x W x H (mm)	Size L x W x H (inches)	Approx. Load Guide (kg)	Pack Qty	Pallet Qty
000451	76 x 76 x 127	3 x 3 x 5	2	25	2,700
000586	102 x 102 x 102	4 x 4 x 4	2	25	2,700
000588	127 x 127 x 127	5 x 5 x 5	2	25	2,100
002056	152 x 102 x 102	6 x 4 x 4	10	25	3,500
000455	152 x 127 x 95	6 x 5 x 3 3/4	2	25	2,400
000524	152 x 152 x 152	6 x 6 x 6	5	25	3,600
000589	178 x 178 x 178	7 x 7 x 7	5	25	2,475
000526	197 x 159 x 159	7 3/4 x 6 1/4 x 6 1/4	5	25	2,475
000577	215 x 180 x 105	8.5 x 7 x 4	5	25	2,200
000528	215 x 215 x 215	8 3/4 x 8 1/2 x 8 1/2	10	25	1,650
000529	229 x 152 x 152	9 x 6 x 6	5	25	3,300
000530	230 x 230 x 130	9 x 9 x 5	5	25	1,650
000531	254 x 152 x 133	10 x 6 x 5 1/4	5	25	3,300
002057	254 x 203 x 203	10 x 8 x 8	10	25	1,650
000590	254 x 254 x 254	10 x 10 x 10	10	25	1,350
000533	280 x 215 x 205	11 x 8 1/2 x 8	10	25	1,650
002058*	305 x 229 x 152/114 (A4 Size)	12 x 9 x 6/4 1/2	10	25	1,925
003168*	305 x 229 x 229/152 (A4 Size)	12 x 9 x 9/6	10	25	1,000
100345	305 x 229 x 229 (A4 Size)	12 x 9 x 9	10	25	1,000
000038	305 x 229 x 305 (A4 Size)	12 x 9 x 12	10	25	900
000537	305 x 305 x 152	12 x 12 x 6	10	25	900
000539	305 x 305 x 255	12 x 12 x 10	10	25	900
000592	305 x 305 x 305	12 x 12 x 12	10	25	900
003231	330 x 255 x 318	13 x 10 x 12 1/2	10	25	900
000542	330 x 330 x 432	13 x 13 x 17	10	25	450
002059	381 x 254 x 254	15 x 10 x 10	10	25	900
000545	381 x 280 x 280	15 x 11 x 11	10	25	900
002062	381 x 330 x 152	15 x 13 x 6	10	25	900
000551*	406 x 356 x 203/152	16 x 14 x 8/6	10	25	450
000552*	410 x 410 x 410/330/229	16 x 16 x 16/13/9	10	25	225
001284	432 x 305 x 130	17 x 12 x 5 1/8	10	25	900
002065	432 x 318 x 268 (A3 Size)	17 x 12 1/2 x 10 1/2	10	25	900
003233	432 x 318 x 318 (A3 Size)	17 x 12 1/2 x 12 1/2	10	25	450
002070	457 x 305 x 305	18 x 12 x 12	10	25	450
001274	457 x 457 x 152	18 x 18 x 6	10	10	450
000582	508 x 305 x 305	20 x 12 x 12	10	20	320
001273	508 x 356 x 356	20 x 14 x 14	10	25	450
002073	508 x 381 x 254	20 x 15 x 10	10	25	450
000557	510 x 457 x 406	20 x 18 x 16	15	20	160
000560	610 x 457 x 305	24 x 18 x 12	15	20	320
000561	610 x 457 x 457	24 x 18 x 18	15	20	160
000562	765 x 255 x 160	30 x 10 x 6 1/4	10	25	450

\* Multi-depth case

Local service with national coverage

Wide product range

Next day delivery available

Stock holding and call-off service



# Double Wall Boxes

Packing with extra strength

Custom sizes and printing available  
Call Us

With over 30 sizes available we offer one of the largest ranges of double-wall boxes in the UK.

The double-wall manufacture, incorporating two rows of specialised fluting, adds all the protection you need to ensure safe transit and lasting storage for heavier or bulky items.

Our commitment to best environmental practice ensures recycled and recyclable materials are used in the production of our corrugated cardboard.

Measured internally for optimum fit – are shown in millimetres: as length x width x height.



The mark of responsible forestry

We can supply these boxes in FSC material.

Internal measurements ensure you make the right choice



Double-wall fluting system is specially designed for maximum strength

Environmental impact rating See page 5



recycle



recyclability category FAP



75% minimum recycled content

don't forget...

Unlined boxes SEE PAGE 38



Machine applied tapes SEE PAGE 97



Bubble bags SEE PAGE 47



Paper document wallets SEE PAGE 34



## Double Wall Boxes

Outstanding protection and durability for heavy or sensitive products.

Multi-depth cases are pre-creased and can be cut down to required height.

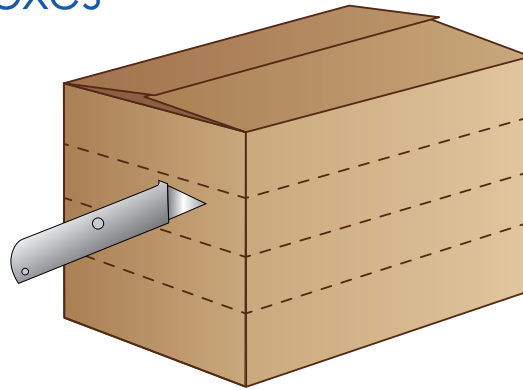

don't forget...

Box corner safety cutter  
SEE PAGE  
132



Boxes

Product Code	Size L x W x H (mm)	Size L x W x H (inches)	Approx. Load Guide (kg)	Pack Qty	Pallet Qty
001563	229 x 152 x 152	9 x 6 x 6	5	15	1080
000257	254 x 254 x 254	10 x 10 x 10	10	20	480
106757	305 x 229 x 114	12 x 9 x 4 1/2	10	20	540
002074	305 x 229 x 229 (A4 size)	12 x 9 x 9	10	20	720
000157	305 x 305 x 305	12 x 12 x 12	15	20	560
002076	350 x 350 x 350	14 x 14 x 14	20	20	240
001350	380 x 245 x 285	15 x 9 5/8 x 11 1/4	20	20	480
004481	386 x 386 x 305	15 1/4 x 15 1/4 x 12	25	20	240
002925	390 x 325 x 150	15 3/8 x 12 3/4 x 5 7/8	20	20	240
004065	406 x 356 x 356	16 x 14 x 14	20	20	240
001212	406 x 406 x 406	16 x 16 x 16	20	20	120
000467	457 x 305 x 254	18 x 12 x 10	25	20	480
000162	457 x 305 x 305	18 x 12 x 12	20	20	240
287942	457 x 305 x 305	18 x 12 x 12	20	20	240
002077	457 x 317 x 381	18 x 12 1/2 x 15	20	20	240
000578	457 x 457 x 305	18 x 18 x 12	20	20	120
000161*	457 x 457 x 457/382/307/232	18 x 18 x 18/15/12/9	25	20	120
000779	457 x 457 x 508	18 x 18 x 20	20	20	120
000579	457 x 457 x 610	18 x 18 x 24	20	10	120
000541	457 x 457 x 762	18 x 18 x 30	20	10	120
001272	508 x 508 x 508	20 x 20 x 20	25	10	120
001271	533 x 330 x 355	21 x 13 x 14	25	20	240
001270	566 x 366 x 254	22 1/4 x 14 3/8 x 10	25	20	240
002284	581 x 406 x 312	22 7/8 x 16 x 12 1/4	20	20	240
002085	610 x 254 x 330	24 x 10 x 13	25	20	240
001269	610 x 457 x 229	24 x 18 x 9	25	20	240
000160*	610 x 457 x 457/382/307/232	24 x 18 x 18/15/12/9	20	10	120
002119	610 x 508 x 406	24 x 20 x 16	20	10	120
000159	610 x 610 x 610	24 x 24 x 24	30	10	120
002917	711 x 558 x 430	28 x 22 x 16 15/16	25	10	120
000777	762 x 457 x 457	30 x 18 x 18	30	10	120
004303	762 x 610 x 508	30 x 24 x 20	20	10	120
002122	762 x 762 x 914	30 x 30 x 36	20	1	120
000776	914 x 610 x 254	36 x 24 x 10	30	5	120

\* Multi-depth case

Local service with national coverage

Wide product range

Next day delivery available

Stock holding and call-off service

## Euro Pallet Boxes

A perfect fit for your Euro pallet.

Tough, heavy-duty double wall, modular boxes offer excellent stacking strength and are designed to provide an exact fit for standard Euro pallets.



### Euro pallet box guide

Reference	Boxes Per Layer
Euro 3	3 boxes per layer on a 800 x 1200 mm pallet
Euro 4/2/1	4 boxes per layer on a 800 x 1200 mm pallet 2 boxes per layer on a 600 x 800 mm pallet 1 box per layer on a 400 x 600 mm pallet
Euro 6	6 boxes per layer on a 800 x 1200 mm pallet
Euro 8/4/2	8 boxes per layer on a 800 x 1200 mm pallet 4 boxes per layer on a 600 x 800 mm pallet 2 boxes per layer on a 400 x 600 mm pallet
Euro 10	10 boxes per layer on a 800 x 1200 mm pallet
Euro 12/6	12 boxes per layer on a 800 x 1200 mm pallet 6 boxes per layer on a 600 x 800mm pallet

Product Code	Reference	Size L x W x H (mm)	Approx. Load (kg)	Pack Qty
004479	Euro 3	786 x 386 x 472	30	10
004480	Euro 4/2/1	586 x 386 x 305	30	20
004481	Euro 6	386 x 386 x 305	30	20
004482	Euro 8/4/2	386 x 286 x 305	30	20
004484	Euro 12/6	286 x 252 x 305	30	20
004483	Euro 10	386 x 226 x 305	30	20

Environmental impact rating See page 5



## Palletised Containers

The complete solution for heavy items.

Palletised containers offer a complete packing solution for shipping heavy items, including cap, tray and sleeve. Palletised containers are supplied with a heat-treated timber pallet, suitable for export.



Product Code	Description	Size (mm) L x W x H	Approx. Load (kg)
001528	1/1 Container	1070 x 870 x 900 ID	200
		1100 x 900 x 1020 OD	
001529	1/1 Europa	1170 x 770 x 660 ID	200
		1200 x 800 x 780 OD	
001530	1/2 Container	1070 x 870 x 550 ID	200
		1100 x 900 x 670 OD	
001531	1/2 Europa	770 x 570 x 660 ID	200
		800 x 600 x 780 OD	

Boxes

Environmental impact rating See page 5



Pallet

Environmental impact rating See page 5



**Ask us about...** heavy duty corrugate pallets which are exempt from ISPM 15. They hold up to 750kg and can reduce shipment weight by around 20kg.





## BDCM Boxes

A range of standard, printed cartons of superior quality commonly used in garment and catalogue trades.

Specially made for use by the clothing, retail and catalogue trades. This designated range of traditional BDCM boxes is printed in blue with the relevant trade category details, as required by many large clothing retailers. Macfarlane supplies BDCM 1, BDCM 2 and BDCM 3 boxes.

Product Code	Reference	Size (mm) L x W x H	Approx. Load Guide (kg)
005150	BDCM 1	595 x 295 x 388	10
002985	BDCM 2	393 x 293 x 393	10
003193	BDCM 3	595 x 295 x 188	10



Specially designed  
in high quality  
cardboard

Printed with  
relevant details  
for garment  
trade shipping



Boxes

Environmental impact rating See page 5



recycle



recyclability  
category  
FAP



minimum  
recycled  
content

## Inka Presswood Pallets

Protection that saves on space – anywhere in the world.

Inka Presswood pallets combine 85% natural wood fibre with a man-made resin. Moulded at high temperature to provide a smooth, solid base which also protects loads from moisture and contamination.

Inka Presswood pallets are compliant with quality standard accreditation on heat-treated products ISPM 15 (International Standards for Phytosanitary Measures).

The nesting design of this pallet saves over 50% of storage space when not in use. The rounded corners, with no nails or screws, are not only safer but also create an ideal surface for shrink or stretch wrapping. The moulded finish provides a solid top deck for ultimate box protection.



Moulded finish  
provides ultimate  
resilience and a  
smoother surface

Nesting design  
saves space

Product Code	Reference	Size (mm)	Approx. Load (kg)	IATA Reference
000615	F44	400 x 600	200	–
001094	F64M	600 x 800	500	1/2 Euro
001433	F8LF2M	800 x 1200	900	1/1 Euro
001096	F8LF2S	800 x 1200	1250	1/1 Euro
001434	F10M	1000 x 1200	900	–

Environmental impact rating See page 5



don't  
recycle



recyclability  
category  
FOR



100% recycled  
content

## Plastic Pallets

Robust, durable plastic pallets; a more cost-effective and longer lasting alternative to wooden pallets. Particularly suitable for the requirements of the fresh produce, information technology, engineering and pharmaceutical sectors where good hygiene and a clean working environment are essential.

Product Code	Size (mm)	Approx Load (kg)
327248	1000 x 1200 x 140	1000
208241	800 x 1200 x 140	1000

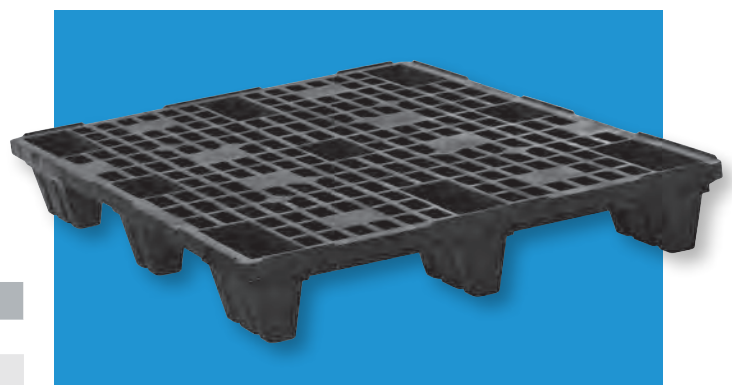

Environmental impact rating See page 5



don't  
recycle



recyclability  
category  
PP



100% recycled  
content

Local service with  
national coverage

Wide product range

Next day delivery  
available

Stock holding and  
call-off service

## Temperature Controlled Packaging

Our range of Temperature Controlled Packaging is suitable for transportation of ambient, chilled and frozen products for cold chain shipping businesses who specialise in perishable and temperature sensitive product.

We also have solutions suitable for bulk supply chain distribution and ecommerce shipments. From pallet covers to postal envelopes, we have temperature controlled packaging for all aspects of your business.

Use of a coolant ensures cold temperatures are maintained in transit. If your products are sensitive to the cold, our products also provide thermal principals that can ensure that heat is retained within the shipment. Our specialist team can advise you on the best products and processes to ensure that your products arrive in perfect condition to its final destination.

## RecycoolMe

Our RecycoolMe shippers are 100% kerbside recyclable. Made from recycled kraft paper, the packs include an outer box with TempGuard™ liners that will keep products below -5°C or between 2°C – 8°C for up to 48 hours, when used with a coolant.

Coolant is not included in the pack and should be purchased separately.

Product Code	Size (mm) L x W x H	Unit
320369	250 x 250 x 250	Each
320379	300 x 300 x 300	Each
320387	355 x 355 x 355	Each

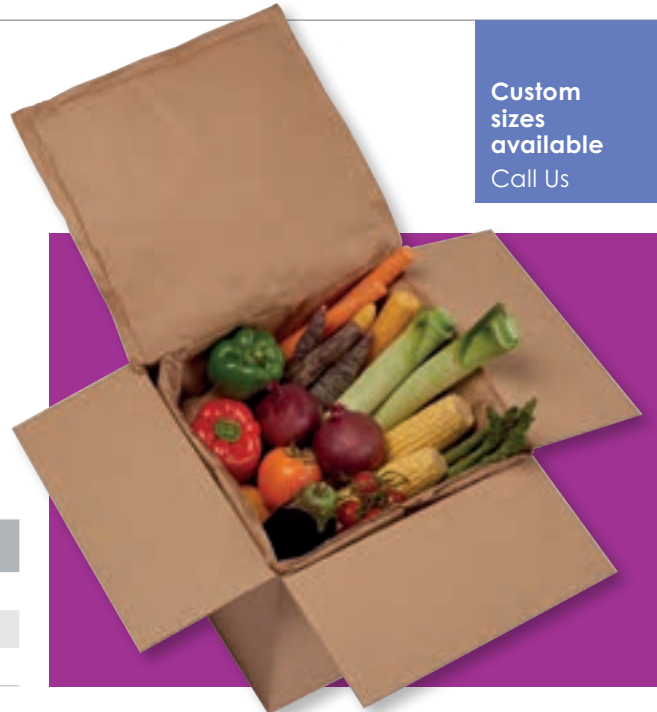

Custom sizes available  
Call Us

### Boxes

Environmental impact rating See page 5



recycle



recyclability category  
FAP



100% recycled content

### Liners

Environmental impact rating See page 5



recycle



recyclability category  
FAP



100% recycled content

We also offer alternate paper inserts that can be dispensed on demand,  
**Speak to us for more details**

See page 73





## CooliMate®

The CooliMate® shipper consists of a double wall outer carton and metallised bubble liners, this coating reflects up to 97% of radiant heat away. When used with a coolant the pack can maintain a temperature of between 2 - 8°C for up to 48 hours.

Coolant is not included in the pack and should be purchased separately.

Product Code	Size (mm) L x W x H	Unit
302678	250 x 250 x 200	Each
302679	290 x 290 x 250	Each
302681	360 x 360 x 300	Each
302683	480 x 480 x 300	Each



Custom sizes available  
Call Us



Boxes

### Boxes

Environmental impact rating See page 5



recycle

recyclability category  
FAP

100% recycled content

### Liners

Environmental impact rating See page 5

don't  
recyclerecyclability category  
OTHER

0% recycled content

Ask us about our temperature controlled bulk supply chain solutions



## Coolants

We recommend that a coolant is used when shipping products that need to maintain a low temperature in transit. **We offer 4 types:**

## Ice sheets

Strong, safe, clean and pure, available in a range of 3 sizes. Please remove water before recycling.

Product Code	Description	Weight	Qty
322325	4 water pockets	250 grams	P80
322328	8 water pockets	500 grams	P44
322330	16 water pockets	1000 grams	P22



Environmental impact rating See page 5

recycle with bags at  
large supermarkets  
DON'T RECYCLE AT HOMErecyclability category  
LDPE

0% recycled content

Local service with national coverage

Wide product range

Next day delivery available

Stock holding and call-off service

## Gel Packs

Highly purified water that has been through a 6 stage filtration, UV sterilisation, softening and chlorination process. Our gel formula is less susceptible to deformations, allowing them to remain a more uniform shape when freezing. Please remove water before recycling.



Product Code	Size	Weight	Qty
322334	170 x 170mm	500 grams	P40

Environmental impact rating See page 5



recycle with bags at large supermarkets  
DON'T RECYCLE AT HOME



recyclability category  
LDPE



0% recycled content

## Hydro-Freeze Ice Packs

A dry ice alternative. To maximise the full effectiveness of these ice packs, they will need to be frozen at a temperature at or below -22°C prior to use to activate the phase change. The colder the better when sending frozen goods. Please remove water before recycling.



Product Code	Size	Weight	Qty
322336	200 x 190mm	66 grams	P34

Environmental impact rating See page 5



recycle with bags at large supermarkets  
DON'T RECYCLE AT HOME



recyclability category  
LDPE



0% recycled content

## Sorbatek

Developed with the seafood industry in mind these maintain temperatures for up to 48 hours when combined with our CooliMate® shipper range. Please note that these require soaking in water before freezing.



Product Code	Size	Weight	Qty
322321	295 x 210mm	500G	P1200
326787	285 x 265mm	750G	P800
322321	295 x 210mm	500G	P100
326787	285 x 265mm	750G	P100
322323	420 x 60m		2 rolls

Environmental impact rating See page 5



don't recycle



NA



0% recycled content



# Bags

## Products

Polythene Bags	22
Grip Seal Polythene Bags	24
Refuse Sacks	26
Paper Bags	27
Carrier Bags	28



Bags



Local service with national coverage

Wide product range

Next day delivery available

Stock holding and call-off service

# Bags

## Polythene Bags

A range of bags to meet all customer needs

Our polythene packing solutions offer a comprehensive choice of bags designed for light, medium and heavy-duty use, in a wide variety of sizes.

We supply across the spectrum of trade and retailer demand.

Available bag attributes:

- Plain
- Printed
- Punched with air holes
- Gusseted
- Perforated on the reel
- Clear / coloured
- Translucent / opaque

Other sizes are available.



Do you need a custom size?  
Call us

Environmental impact rating See page 5



recycle with bags at large supermarkets  
DON'T RECYCLE AT HOME



recyclability category  
LDPE



30% minimum recycled content

## Light duty - Suitable up to 100g

Product Code	Size (mm)	Size (inches)	Pack Qty	Case Qty
004486	100 x 150	4 x 6	1,000	10,000
004491	175 x 225	7 x 9	1,000	6,000
004493	200 x 250	8 x 10	1,000	6,000
004494	200 x 300	8 x 12	1,000	6,000
100380	225 x 300	9 x 12	1,000	3,000
004497	250 x 300	10 x 12	1,000	3,000
004498	250 x 375	10 x 15	1,000	2,000
004499	300 x 375	12 x 15	1,000	2,000
004500	300 x 450	12 x 18	1,000	2,000
000911	375 x 500	15 x 20	1,000	1,000
000912	450 x 600	18 x 24	500	500
000913	500 x 750	20 x 30	500	500
003097	600 x 900	24 x 36	500	500
002001	750 x 900	30 x 36	250	500

## Medium duty - Suitable up to 200g

Product Code	Size (mm)	Size (inches)	Pack Qty	Case Qty
004506	100 x 150	4 x 6	1000	10,000
002006	100 x 200	4 x 8	1000	5,000
004507	125 x 225	5 x 9	500	5,000
002010	150 x 250	6 x 10	1000	4,000
004511	175 x 225	7 x 9	1000	3,000
004513	200 x 250	8 x 10	1000	3,000
004514	200 x 300	8 x 12	500	3,000
004515	225 x 300	9 x 12	500	2,000
004516	250 x 300	10 x 12	500	2,000
004518	250 x 375	10 x 15	500	1,500
004520	300 x 375	12 x 15	500	1,500
004521	300 x 400	12 x 16	500	1,500
004522	300 x 450	12 x 18	500	1,500
002011	300 x 600	12 x 24	500	500
00356	375 x 500	15 x 20	500	500
002012	400 x 500	16 x 20	500	500
003109	450 x 600	18 x 24	250	500
00361	500 x 750	20 x 30	250	250
000359	600 x 900	24 x 36	250	250
002034	750 x 1050	30 x 42	125	200
002036	900 x 1200	36 x 48	100	125



Bags

## Heavy duty - Suitable up to 400g

Product Code	Size (mm)	Size (inches)	Pack Qty	Case Qty
004501	100 x 150	4 x 6	500	4,000
004502	150 x 200	6 x 8	500	2,000
000364	200 x 250	8 x 10	250	1,000
002037	250 x 300	10 x 12	250	500
000365	250 x 375	10 x 15	250	500
000368	300 x 300	12 x 12	250	500
002038	300 x 400	12 x 16	250	500
002039	300 x 450	12 x 18	250	500
000369	400 x 450	16 x 18	250	500
002040	400 x 500	16 x 20	200	250
000370	450 x 600	18 x 24	100	250
000660	450 x 750	18 x 30	100	250
002044	500 x 750	20 x 30	100	200
002045	600 x 900	24 x 36	100	100

don't forget...

SEE PAGE 12

Single wall boxes

SEE PAGE 101

Heat sealers

SEE PAGE 132

Polythene cutter

SEE PAGE 38

Unlined boxes

Local service with national coverage

Wide product range

Next day delivery available

Stock holding and call-off service



## Grip Seal Polythene Bags

Secure closure with re-sealable opening

Grip seal polythene bags form a firm closure to keep contents sealed and secure, to re-seal when required.

Grip seal polythene bags are also fully recyclable.

Available with or without white write-on panels for easy identification.

Available in a selection of sizes.



## Write-on Panels Grip Seal Bags

Medium Duty  
Suitable for up to 180g

Our medium duty grip seal polythene bags are specially manufactured with three white write-on panels for the quick checking of content.

Product Code	Ref	Size (mm)	Size (inches)	Pack Qty	Case Qty
001167	GA020	40 x 65	1½ x 2½	1,000	40,000
001168	GA120	60 x 60	2¼ x 2¼	1,000	20,000
001169	GA121	60 x 75	2¼ x 3	1,000	20,000
001170	GA122	75 x 85	3 x 3¼	1,000	20,000
001171	GA123	90 x 115	3½ x 4½	1,000	12,000
001172	GA124	115 x 115	4½ x 4½	1,000	10,000
001173	GA125	100 x 140	4 x 5½	1,000	10,000
001174	GA126	140 x 140	5½ x 5½	1,000	6,000
001175	GA127	75 x 190	3 x 7½	1,000	6,000
001176	GA128	125 x 190	5 x 7½	1,000	6,000
001177	GA129	190 x 190	7½ x 7½	1,000	6,000
001178	GA130	150 x 230	6 x 9	1,000	6,000
001179	GA131	205 x 280	8 x 11	1,000	3,000
001180	GA132	230 x 325	9 x 12¾	500	2,000
001181	GA133	255 x 355	10 x 14	500	1,000



Environmental impact rating See page 5



recycle with bags at large supermarkets  
DON'T RECYCLE AT HOME



recyclability category  
LDPE



minimum recycled content

# Plain Grip Seal Bags

Other sizes are available  
Call Us

Ask us about our bags made with recycled content  
Call Us



Bags

## Medium Duty Suitable for up to 180g

Durable, sealed storage with re-sealable fastening in a range of 20, small to large sizes, from 40mm x 65mm to 380mm x 510mm.

## Heavy Duty Suitable for up to 300g

These heavy duty bags provide extra tough quality with grip and seal fastening.

### Heavy Duty

Product Code	Ref	Size (mm)	Size (inches)	Pack Qty	Case Qty
000477	GL.20	125 x 205	5 x 8	1,000	5,000
000097	GL.30	180 x 255	7 x 10	1,000	2,000
000481	GL.40	205 x 305	8 x 12	1,000	2,000
000504	GL.50	230 x 355	9 x 14	1,000	1,000
000666	GL.60	305 x 405	12 x 16	500	1000
000673	GL.70	255 x 455	10 x 18	500	500

### Medium Duty

Product Code	Ref	Size (mm)	Size (inches)	Pack Qty	Case Qty
001148	GL0	40 x 65	1½ x 2½	1,000	40,000
003727	GL105	50 x 230	2 x 9	1,000	12,000
001149	GL1	60 x 60	2¼ x 2¼	1,000	20,000
001150	GL2	60 x 75	2¼ x 3	1,000	20,000
001151	GL3	75 x 85	3 x 3¼	1,000	20,000
001152	GL4	90 x 115	3½ x 4½	1,000	12,000
001153	GL5	115 x 115	4½ x 4½	1,000	10,000
001154	GL6	100 x 140	4 x 5½	1,000	10,000
001155	GL7	140 x 140	5½ x 5½	1,000	6,000
001156	GL8	75 x 190	3 x 7½	1,000	6,000
001157	GL9	125 x 190	5 x 7½	1,000	6,000
001158	GL10	190 x 190	7½ x 7½	1,000	6,000
001159	GL11	150 x 230	6 x 9	1,000	6,000
001160	GL12	205 x 280	8 x 11	1,000	3,000
001161	GLA4	230 x 325	9 x 12¾	500	2,000
001162	GL13	325 x 325	12¾ x 12¾	500	1,000
001163	GL14	255 x 355	10 x 14	500	1,000
001164	GL15	280 x 405	11 x 16	500	1,000
001165	GL16	330 x 455	13 x 18	500	1,000
001166	GL17	380 x 510	15 x 20	500	1,000

Environmental impact rating See page 5



recycle with bags at large supermarkets  
DON'T RECYCLE AT HOME



recyclability category  
LDPE



minimum recycled content

Local service with national coverage

Wide product range

Next day delivery available

Stock holding and call-off service

# Recycling Refuse Sacks

Coloured options available  
Call Us

Colour-coded system for easy sorting

Bags can be used with Macfarlane's cardboard office recycling bin.

Product Code	Description	Size (mm)	Pack Qty
001230	Black	457 x 725 x 850	200
003171	Large Black	457 x 725 x 975	200
001952	Blue	457 x 725 x 975	200
004600	Clear	457 x 725 x 975	200
004237	Recycling Bin	313 x 313 x 742	50



Environmental impact rating See page 5



# Rubble Sacks and Wheelie Bin Bags

Made from heavy-duty blue polythene. Ideal for disposal of builders' rubble and all heavyweight waste.

The recycling refuse sacks can be used in conjunction with our office recycling bin, above.

Product Code	Description	Size (mm)	Pack Qty
005118	Rubble Sack	500 x 750	100
005990	Wheelie Bin Liner	760 x 1165 x 1370	100

Environmental impact rating See page 5



don't forget...

SEE PAGE 12  
Single wall boxes

SEE PAGE 101  
Heat sealers

SEE PAGE 132  
Polythene cutter

SEE PAGE 38  
Unlined boxes



# Paper Carrier Bags

Kraft paper carrier bags, available in a choice of white or brown paper, comes with strong handles and a gusseted base, facilitating packing and creating effective presentation.

Custom printing available  
Call Us

Luxury bags available  
Call Us

Product Code	Description	Size L x W x H (mm)	Pack Qty
001120	Small Brown Paper Carrier Bags	175 x 263 x 215	250
001124	Small White Paper Carrier Bags	175 x 263 x 215	250
001121	Medium Brown Paper Carrier Bags	200 x 325 x 250	250
001125	Medium White Paper Carrier Bags	200 x 325 x 250	250
001123	Large Brown Paper Carrier Bags	263 x 388 x 313	250
001126	Large White Paper Carrier Bags	263 x 388 x 313	250



Bags

Environmental impact rating See page 5



recycle



recyclability category  
FAP



0% recycled content

# Paper Bags

Product Code	Size (mm)	Pack Qty
000154	175 x 175	1000
000167	175 x 238	1000
000178	175 x 375	500
000158	250 x 250	1000
000163	250 x 300	1000
000164	250 x 360	1000
000166	300 x 313	500
000168	325 x 350	500
000172	350 x 450	500
000173	475 x 525	500



Environmental impact rating See page 5



recycle



recyclability category  
FAP



0% recycled content

don't forget...

Retractable Packing Knife

SEE PAGE  
132



Warning tape

SEE PAGE  
95



Polypropylene Hand Strapping

SEE PAGE  
118

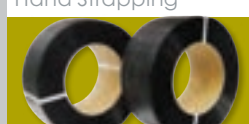

Hand-Applied Blown Stretch Film

SEE PAGE  
110

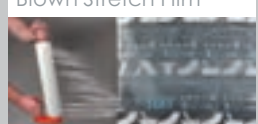

Local service with national coverage

Wide product range

Next day delivery available

Stock holding and call-off service

Custom printing & colours available  
Call Us

## Polythene Carrier Bags

This versatile range of bags are available in recycled white and blue polythene for either light or medium-duty wear.



Product Code	Description	Micron	Colour	Size (mm)	Pack Qty
008443	Recycled	23	Blue	280 x 410 x 510	1,000
008441	Recycled	14	White	280 x 410 x 510	2,000

Environmental impact rating See page 5



recycle with bags at large supermarkets  
DON'T RECYCLE AT HOME

recyclability category  
LDPE

50% minimum recycled content

## Gusseted Paper Sacks

This range of brown paper sacks are made from high quality, multi-ply, kraft paper, which is 100% recyclable. The sacks are thick and tough, with the special stitching at the base underpinning the strength and durability – perfect for keeping your products contained safely.

Custom sizes available  
Call Us



Product Code	Ply	Size (mm)	Pack Qty
000231	2	225 x 75 x 450	100
000041	2	325 x 100 x 450	100
000922	2	325 x 100 x 700	100
000525	2	400 x 225 x 975	100
000040	2	412 x 75 x 525	100
000490	2	412 x 75 x 875	50
000898	3	450 x 100 x 900	50

Environmental impact rating See page 5



recycle



recyclability category  
FAP



0% recycled content



# Postal

## Products

Bubble Lined Mailers	30
Padded Mailers	32
Mailing Bags	33
Document Wallets	34
Postal Envelopes	35
Postal Wraps	35
Postal Tubes	36
eCommerce Range	37
Korrvu® Insert	37
Postal Boxes	38
Flexi-Hex®	41
Airsac®	42



Postal



Local service with national coverage

Wide product range

Next day delivery available

Stock holding and call-off service

# Postal



Custom printing available  
Call Us

## Mail Lite® White & Gold

Mail Lite® mailing products make up the most complete line of cushioned and non-cushioned mailers in the industry.

Our Mail Lite® mailers now use PE coated paper FSC® certified paper which can easily be recycled in the paper waste stream.

This also means it is now easy to separate the bubble from the outer paper without compromising the cushioning performance. The internal bubble is made with at least 30% recycled content.



### Mail Lite® White

Product Code	Ref No.	Internal Dimensions (mm)	Royal Mail PIP	Pack Qty	Pallet Qty
003619	A/000	110 x 160	Letter	100	88
004852	B/00	120 x 210	Letter	100	64
004853	C/0	150 x 210	Letter	100	55
004854	D/1	180 x 260	Large Letter	100	40
004855	E/2	220 x 260	Large Letter	100	32
004856	F/3	220 x 330	Large Letter	50	55
007800	LL	230 x 330	Large Letter	50	44
004857	G/4	240 x 330	Small Parcel	50	44
004858	H/5	270 x 360	Small Parcel	50	40
004859	J/6	300 x 440	Small Parcel	50	24
004860	K/7	350 x 470	Medium Parcel	50	24

### Mail Lite® Gold

Product Code	Ref No.	Internal Dimensions (mm)	Royal Mail PIP	Pack Qty	Pallet Qty
001491	A/000	110 x 160	Letter	100	88
007984	B/00	120 x 210	Letter	100	64
001493	C/0	150 x 210	Letter	100	55
001494	D/1	180 x 260	Large Letter	100	40
001495	E/2	220 x 260	Large Letter	100	32
001496	F/3	220 x 330	Large Letter	50	55
007801	LL	230 x 330	Large Letter	50	44
001497	G/4	240 x 330	Small Parcel	50	44
001498	H/5	270 x 360	Small Parcel	50	40
001499	J/6	300 x 440	Small Parcel	50	24
001500	K/7	350 x 470	Medium Parcel	50	24

#### Paper liner

Environmental impact rating See page 5



recycle



recyclability category  
PAPER



minimum recycled content

#### Bubble inner

Environmental impact rating See page 5



don't recycle



recyclability category  
OTHER



minimum recycled content



Custom printing available  
Call Us

## Mail Lite® Plus

Safe cover for fragile items, at lightweight cost

- Extra protective postal bag made with strong oyster white Kraft outer lined with AirCap® barrier-sealed bubble providing excellent stiffness, puncture resistance and rugged durability
- Typical cost savings of 20-35% over traditional packaging
- Self-seal closure saves time in busy packaging departments
- Application: heavy or fragile objects such as motor spares, electronic parts etc
- FSC® paper outer on this product and 30% recycled content bubble



Product Code	Ref No.	Internal Dimensions (mm)	Royal Mail PIP	Pack Qty	Pallet Qty
004841	A/000	110 x 160	Letter	100	66
004842	B/00	120 x 210	Letter	100	36
004843	C/0	150 x 210	Letter	100	39
004844	D/1	180 x 260	Large Letter	100	33
004845	E/2	220 x 260	Large Letter	100	24
004846	F/3	220 x 330	Large Letter	50	39
007802	LL	230 x 330	Large Letter	50	33
004847	G/4	240 x 330	Small Parcel	50	33
004848	H/5	270 x 360	Small Parcel	50	24
004849	J/6	300 x 440	Small Parcel	50	18
004850	K/7	350 x 470	Medium Parcel	50	18



Postal

Environmental impact rating See page 5



don't recycle



Custom printing available  
Call Us

## Mail Lite Tuff®

Cushioned Mailers

**Tough Polyethylene outer:** easy to write on, waterproof, excellent stamp and label adhesion

**High puncture and tear resistance,** due to an extra-strong polyethylene outer layer

**Lightweight:** total shipping weight is reduced

**Shock-resistant:** The bubble film lining guarantees outstanding protection safeguarding your products from shock and vibration

**Water-resistant:** Mail Lite® Tuff Cushioned Mailers protect your products, whatever the weather



Product Code	Ref No.	Internal Dimensions (mm)	Royal Mail PIP	Pack Qty	Pallet Qty
006916	CD	180 x 160	Letter	100	24
006920	C/0	150 x 210	Letter	100	30
006921	D/1	180 x 260	Large Letter	100	20
006922	G/4	240 x 330	Small Parcel	50	24
006924	H/5	270 x 360	Small Parcel	50	24
006928	K/7	350 x 470	Medium Parcel	50	12

Environmental impact rating See page 5



don't recycle



Local service with national coverage

Wide product range

Next day delivery available

Stock holding and call-off service





## Padded Mailers

Eco-friendly envelopes with a unique tear strip

- Improved and "Naturally Better" paper padded mailer providing excellent product protection
- Environmentally friendly - 100% recycled paper, and recyclable
- Convenient tear strip for simple, clean opening
- Smooth inner lining allows easy product insertion and a re-scored flap makes closure more efficient
- Peel and seal closure

Product Code	Ref No.	Internal Dimensions (mm)	Royal Mail PIP	Pack Qty	Pallet Qty
002547	B/00	124 x 222	Letter	100	36
002552	C/0	149 x 222	Letter	100	39
002557	D/1	181 x 273	Large Letter	100	33
002558	E/2	213 x 273	Large Letter	100	24
002560	F/3	213 x 336	Large Letter	50	39
002565	G/4	238 x 336	Small Parcel	50	33
002579	H/5	264 x 374	Small Parcel	50	24
002604	J/6	314 x 450	Medium Parcel	50	18
002605	K/7	362 x 476	Medium Parcel	50	36
002606	L/8	656 x 458	Large Parcel	50	18

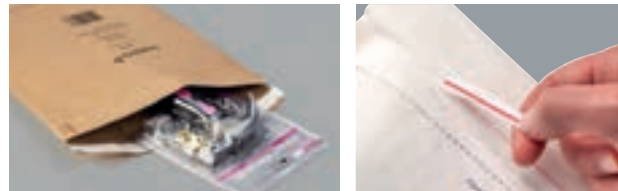

## Curby Mailers™

A one-to-one replacement for single-use-plastic padded mailers, Curby Mailers™ contain an integrated honeycomb paper structure to protect your products. Curby Mailers™ are kerbside recyclable, making them an excellent choice for home deliveries.

Product Code	Size (mm)	Pack Qty	Pallet Qty
1001067	216 x 300	120	1080
1001068	406 x 260	120	960
1001069	486 x 320	120	720



Environmental impact rating See page 5



recycle



recyclability category  
FAP



0% recycled content

## Enviroflute

All paper padded bags, Enviroflute is an alternative to the traditional bulky padded mailers, made from FSC® paper, and offering the same level of protection via a patented internal design.



Short Code	Product Code	Internal Dims (mm)	Royal Mail PIP	Pack Quantity	Pallet Quantity
304412	EF 000/A	110 x 165	Letter	200	9600
304413	EF 00/B	120 X 215	Letter	200	7200
304414	EF 0/C	150 X 215	Letter	200	6000
304415	EF 1/D	180 X 265	Large Letter	200	4400
304416	EF 2/E	220 X 265	Large Letter	200	3600
304417	EF 3/F	220 X 330	Large Letter	100	3000
304418	EF 4/G	240 X 330	Large Letter	100	2700
304419	EF 5/H	270 X 360	Small parcel	100	2400
304420	EF 6/J	300 X 440	Small parcel	100	1500
304421	EF 7/K	350 X 470	Medium parcel	100	1500

Environmental impact rating See page 5



recycle



recyclability category  
FAP



0% recycled content



## Mail Tuff®

### Durable Mailers

Resilient inner adds security in the post

**Very Resistant:**

Manufactured from polyethylene film, Mail Tuff® envelopes are highly resistant to tearing and punching

**Product Security:**

Mail Tuff® ensures your product arrives safely

- Strong side-welded seams allow for over-stuffing without risk of bursting
- Strong permanent adhesive ensures goods remain safely sealed inside
- Closure system is tamper evident to unauthorised opening
- Opaque Mail Tuff® ensures confidentiality and security
- Ideal way to dispatch non-fragile items, confidential or sensitive reports

**Waterproof:**

The polyethylene construction makes sure the contents are protected from water and the elements



Product Code	Ref No.	Internal Dimensions (mm)	Royal Mail PIP	Pack Qty	Pallet Qty
002660	MT1	165 x 240	Letter	100	336
002661	MT2	230 x 320	Large Letter	100	261
002662	MT3	250 x 350	Large Letter	100	156
002663	MT4	295 x 415	Small Parcel	100	84
002664	MT5	406 x 400	Medium Parcel	100	44
002665	MT6	450 x 525	Medium Parcel	100	46

**Environmental impact rating** See page 5

don't recycle
 recyclability category LDPE
 50% minimum recycled content

## Mailing Bags

High confidentiality and added security in a waterproof, write-on bag. The opaque design conceals the nature of the content, while the waterproof polythene also protects products from wet and dirt.

**Recycled content mailers available on request**

**Alternate colours available on request**

Product Code	Internal Dimensions (mm)	Royal Mail PIP	Pack Qty
321561	230 x 310	Large Letter	1,000
287085	250 x 350	Large Letter	1,000
321565	320 x 440	Small Parcel	500
321566	350 x 500	Medium Parcel	500
321567	425 x 600	Medium Parcel	500
321568	550 x 750	Large Parcel	250
321570	575 x 700	Large Parcel	250
321571	600 x 900	Large Parcel	200



**Environmental impact rating** See page 5

recycle with bags at large supermarkets DON'T RECYCLE AT HOME
 recyclability category LDPE
 0% recycled content

Local service with national coverage

Wide product range

Next day delivery available

Stock holding and call-off service

## Paper Mailing Bags

These environmentally-friendly paper bags are recyclable and have a self-sealing strip that helps ensure products are securely locked inside the bag during transport. As no extra adhesive is required, the packages look neat and the in-built tear strip makes them easy to open – all this contributes to creating a positive customer experience. The bags are available in different sizes to suit different products and packaging needs.



Product Code	Size (mm)	Royal Mail PIP	Pack Size
304721	190 x 300	Large Letter	500
304726	250 x 353	Large Letter	250
304724	260 x 410	Small Parcel	300
304725	300 x 430	Small Parcel	200

## Gusseted Paper Mailing Bags

Product Code	Size (mm)	Royal Mail PIP	Pack Size
311195	240 x 340 x 60	Large Letter	50
311200	255 x 425 x 75	Small Parcel	50
311206	280 x 445 x 60	Small Parcel	50

Environmental impact rating See page 5



recycle



recyclability category  
PAP



0% recycled content

## Paper Document Wallets

These paper document wallets are transparent to enable the document to be read easily for identification purposes, and with a strong self-adhesive backing, these are very quick to apply whilst also ensuring that packing documents don't fall off whilst in transit. This product will also save you time as you don't have to remove them from the cardboard box prior to recycling.



Product Code	Reference	Internal Dimensions (mm)	Pack Qty
304141	A5 Paper Document Wallets	228 x 165	1000
304140	A6 Paper Document Wallers	162 x 120	1000

Environmental impact rating See page 5



recycle



recyclability category  
PAP



50% minimum recycled content

## Document Wallets

Self-adhesive attachment shows delivery details

These labour-saving, self-adhesive, clear-fronted polythene envelopes are designed to attach product documentation, including invoices or customs paperwork to the outside of parcels.



Custom printing available  
Call Us

### Plain

Product Code	Reference	Internal Dimensions (mm)	Pack Qty
000921	A6 Plain Document Wallets	165 x 122	1,000
000920	A5 Plain Document Wallets	225 x 165	1,000
000479	A4 Plain Document Wallets	318 x 235	500
001262	DL (Din Long) Plain Document Wallets	225 x 122	1,000

### Printed

Product Code	Reference	Internal Dimensions (mm)	Pack Qty
000572	A6 Printed "Docs Enclosed" Wallets	165 x 122	1,000
000919	A5 Printed "Docs Enclosed" Wallets	225 x 165	1,000
007153	A4 Printed "Docs Enclosed" Wallets	318 x 235	500
001263	DL (Din Long) Printed "Docs Enclosed" Wallets	225 x 122	1,000

Environmental impact rating See page 5



recycle



recyclability category  
LDPE



30% minimum recycled content





## Postal Envelopes

Great mail order postal envelopes conforming to Royal Mail PIP All Large Letter Guidelines

Postal Envelopes are fitted with a peel and seal closure. Items are delivered flat packed and sizes shown are the internal dimensions: Length x Width x Depth. The board envelopes are gusseted to expand from 0-30 mm.

Product Code	Ref	Colour	Size (mm)	Pack Qty
256356	PE1	Brown	234 x 175 x 0-30	50
256371	PE2	Brown	290 x 190 x 0-30	50
256372	PE3	Brown	330 x 230 x 0-30	50
256373	PE4	Brown	350 x 245 x 0-30	50



Postal

Environmental impact rating See page 5



recycle



recyclability  
category  
FAP



minimum  
recycled  
content

## Postal Wraps

Cleverly designed, self-sealing, to ship books and other solid, flat items

Wraps fit tightly around flat items and require no additional wrapping or packaging.

No packing tape is required for assembly but taping your postal packs before mailing gives added security.

Product Code	Reference	Internal Size (mm) L x W x H	Royal Mail PIP	Pack Qty
256377	PW1	236 x 158 x 0-60	Large Letter	25
256385	PW2	251 x 185 x 0-60	Large Letter	25
256391	PW3	298 x 200 x 0-70	Large Letter	25
256392	PW4	301 x 232 x 0-47	Large Letter	25
256393	PW5	333 x 270 x 0-50	Small Parcel	25
256380	PW6	412 x 321 x 0-57	Medium Parcel	25
256384	PW7	430 x 380 x 0-90	Medium Parcel	25

Custom  
sizes  
available  
Call Us



Environmental impact rating See page 5



recycle



recyclability  
category  
FAP



minimum  
recycled  
content

Local service with  
national coverage

Wide product range

Next day delivery  
available

Stock holding and  
call-off service

# Postal Tubes

Custom sizes available  
Call Us

No-crush cover for plans and posters.

Macfarlane's postal tubes provide excellent cover for storing and shipping plans, prints and posters.

All of our postal tubes are supplied with snug-fitting, white plastic end caps, designed to secure the contents in transit without creasing or crushing.

The diameter of the tube is measured across the internal wall, for accurate fitting.

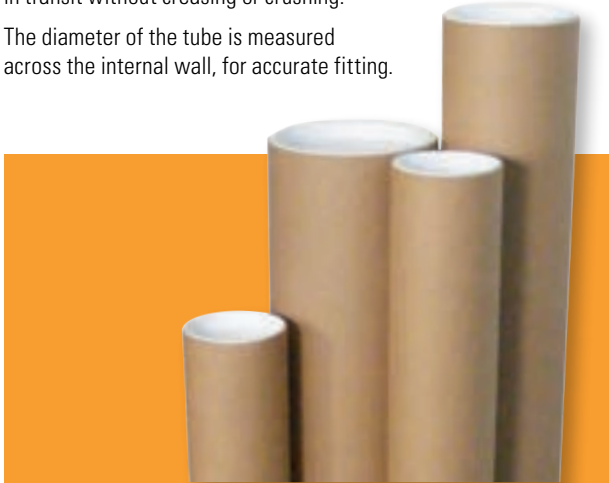

Product Code	Length (mm)	Width (mm) Diameter	Wall (mm) Thickness	Pack Qty
001600	330	44.5	1.5	100
001601	450	44.5	1.5	100
001602	559	50.8	1.5	100
001603	640	50.8	1.5	100
001604	450	63.5	1.5	100
001605	640	63.5	1.5	100
001606	813	63.5	1.5	100
001607	559	76	1.5	100
001608	640	76	1.5	100
001609	813	76	2	100
001610	940	76	2	100
001611	1046	76	3	100
001612	640	100	3	100
001613	940	100	3	100
001614	1046	100	3	100
001615	940	127	3	100
001616	1046	152	3	100

\* Excluding end caps, 10% post waste, LDPE, category 4

Environmental impact rating See page 5



recycle\*



recyclability\* category P4P



100% recycled\* content

# eCommerce Crash-Lock

Our eCommerce crash lock boxes are quick to erect and fast to pack. The smart base pops open for easy assembly, eliminating the need for tape. The boxes are great for a wide range of products including beauty items, homeware and gifts. The boxes feature an easy-to-open tear strip for a better customer experience and self-seal strip for faster packing. These sturdy, eCommerce boxes come in three different sizes.



Product Code	Size (mm) L x W x H	Pack Qty	Pallet Qty
271147	182 x 111 x 60	20	4000
271149	250 x 130 x 80	20	2640
271157	300 x 180 x 110	20	1320

Environmental impact rating See page 5



recycle



recyclability\* category P4P



75% minimum recycled content

don't forget...

Retractable Packing Knife

SEE PAGE 132



Warning tape

SEE PAGE 95



Polypropylene Hand Strapping

SEE PAGE 118

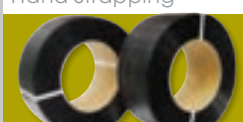

Hand-Applied Blown Stretch Film

SEE PAGE 110

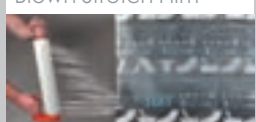

## eCommerce Box

Our wide range of eCommerce boxes are great for garments and accessories. Boxes are quick to assemble and come in three sizes offering excellent presentation of your items. The boxes feature a self-seal strip to eliminate the need for tape and improve speed of packing. When the boxes arrive on your customers' doorstep they are easy to open as they feature a handy tear strip.

Product Code	Size (mm) L x W x H	Pack Qty	Pallet Qty
271161	225 x 225 x 60	50	2600
271158	370 x 230 x 100	50	1300
271162	460 x 370 x 85	50	650



Environmental impact rating See page 5



recycle



recyclability  
category  
PAP



75%  
minimum  
recycled  
content



Postal

## eCommerce Transit Box

Our eCommerce transit box comes with a crash lock base which are quick to erect and fast to pack. The transit box is strong and sturdy and has folded flaps for easy sealing and increased security. Great for large homeware items, mixed clothing and medium food hampers.

Product Code	Size (mm) L x W x H	Pack Qty	Pallet Qty
271166	305 x 229 x 229	20	720
271163	432 x 318 x 318	20	360



Environmental impact rating See page 5



recycle



recyclability  
category  
PAP



50%  
minimum  
recycled  
content

## Korrvu® Insert

Reduces the need for additional void filling or wrapping.

Korrvu® is a dynamic packaging product that uses a strong, highly-resilient low-slip film to surround your products, protecting them from shock and vibration by ensuring your product holds centre place inside the box.

Beautiful presentation and high protection.

Great for beauty products and electronic items.

Product Code	Size (mm) L x W x H
271743	182 x 96 x 58
271745	232 x 126 x 78
271751	300 x 180 x 110

More Korrvu®  
products  
available on  
page 57



Insert (including the film) can be recycled as film is less than 5% in weight of the insert

Environmental impact rating See page 5



recycle



recyclability  
category  
PAP



30%  
minimum  
recycled  
content

Local service with  
national coverage

Wide product range

Next day delivery  
available

Stock holding and  
call-off service

## Unlined Postal Boxes

Single walled packing solution for easy shipping

Custom sizes available  
Call Us

Sturdy postal boxes provide secure packaging in transit for small to larger and harder to wrap items.

The special tuck-in locking flap facilitates closure and sealing, with a printed security label for each box.

Product Code	Colour	Size (mm) L x W x H	Pack Qty
004523	White	130 x 115 x 90	100
004524	White	145 x 130 x 52	100
004525	White	152 x 57 x 57	100
004526	White	201 x 126 x 55	100
004527	White	246 x 216 x 55	100
004528	White	275 x 180 x 80	100
004529	White	300 x 240 x 100	50
004530	White	360 x 280 x 80	50
004531	White	426 x 261 x 55	50



Environmental impact rating See page 5



recycle



recyclability category  
FAP



100% recycled content

## Postal Boxes

Great mail order postal boxes conforming to PIP Guidelines

A range of mailing boxes that fall within the Royal Mail Small Parcel guidelines, these postal boxes come flat packed for easy assembly.

Product Code	Ref.	Internal Size (mm) L x W x H	Pack Qty
256396	PB1	100 x 95 x 105	1
256398	PB2	125 x 115 x 115	1
256409	PB3	200 x 150 x 100	50
256402	PB4	202 x 96 x 78	50
256404	PB5	252 x 136 x 88	50
256410	PB6	255 x 165 x 45	50
256411	PB7	285 x 195 x 125	50
256407	PB8	320 x 200 x 130	50



Environmental impact rating See page 5



recycle



recyclability category  
FAP



75% minimum recycled content

## Foam Lined Postal Boxes (Oyster Packs)

Protection for your valuable items

Cost-effective, recyclable, die-cut boxes with a soft foam lining assure safekeeping for valuable items in the post.

Boxes are designed with a tuck-in locking flap, with white foam insert included.

Product Code	Reference	Size (mm) L x W x H	Pack Qty
001933	No. 1	201 x 126 x 55	128
001934	No. 2	246 x 216 x 55	64
001444	No. 2A	275 x 180 x 80	50
001935	No. 3	426 x 261 x 55	32
001445	No. 3A	360 x 280 x 80	25
001448	No. 4	525 x 385 x 80	25
001471	Keyboard Pack	500 x 250 x 78	25



Custom sizes available  
Call Us



Postal

## Foam Lined Postal Sleeves (Shell Packs)

Protection for delicate contents

Simply designed shell and slide carton, with an 'egg-box' style, laminated profile foam liner, these postal sleeves provide protection for delicate contents. Items such as circuit boards, jewellery, photographic equipment and precision instruments can all be posted with confidence.

Product Code	Reference	Size (mm) L x W x H	Pack Qty
000583	No.1	180 x 120 x 50	100
000584	No.2	275 x 180 x 50	50
000670	No.2A	275 x 180 x 80	50
000585	No.3	360 x 280 x 50	25
000671	No.3A	360 x 280 x 80	25
000672	No.4	525 x 385 x 80	25

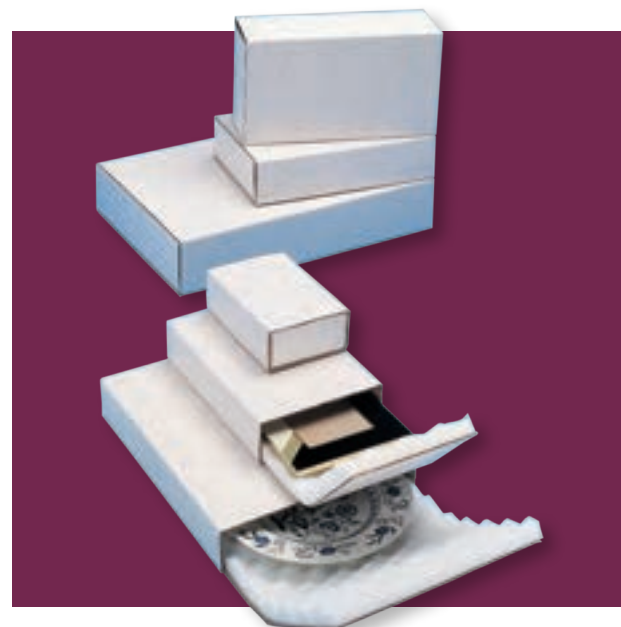

Available with anti-static foam

Oyster Packs & Shell Packs – Boxes

Environmental impact rating See page 5



Oyster Packs & Shell Packs – Foam

Environmental impact rating See page 5



Local service with national coverage

Wide product range

Next day delivery available

Stock holding and call-off service



## PC Component Packs

Ultimate protection for the most delicate, precision, or electronic items. Packs comprise of a die cut box with top and bottom profiled foam.

Suitable for hard drives up to 3 1/2" (8.75 cm) and many electrical components.



Product Code	Size (mm) L x W x H	Pack Qty
005806	210 x 154 x 85	50
005954	257 x 200 x 95	50

### Boxes

Environmental impact rating See page 5



recycle



recyclability category  
PAP



minimum recycled content

### Foam

Environmental impact rating See page 5



don't recycle



recyclability category  
OTHER



recycled content

## Wine Bottle Boxes

Strong, durable bottle boxes are suitable for holding either 6 or 12 wine bottles and can be used for shipping and storage.

A simple, pop up divider insert makes these boxes quick & easy to construct use.



Product Code	Suitable for	Size (mm)	Pack Qty
219023	6 bottles	283 x 198 x 340	10
219019	12 bottles	396 x 271 x 340	10

Environmental impact rating See page 5



recycle



recyclability category  
PAP



minimum recycled content

# Flexi-Hex®

Flexi-Hex® is plastic free, biodegradable concertina style honeycomb protector ideal for bottle protection.

The product is a great alternative to polystyrene bottle packs. Flexi-Hex® is available for retail and gifting or as an ecommerce pack for shipping.

They arrive flat packed and are easy to assemble, offering storage savings. The product provides high compression resistance and can be printed.

Custom printing available  
Call Us



Product code: 301597

## eCommerce Pack- Boxes

Product Code	Description	Pack Qty
300031	1 Bottle Pack	100
300666	2 Bottle Pack	100
300667	3 Bottle Pack	100
299269	Sleeve	100



Postal

## Gift Pack- Kit

Product Code	Description	Pack Qty
301597*	Slender Capsule	100

\*Consists of outer sleeve, cap and strip



Product Code: 299269



Product Code: 300031



Product Code: 300667



Product Code: 300666

Environmental impact rating See page 5



recycle



recyclability category P4P



75% minimum recycled content

Local service with national coverage

Wide product range

Next day delivery available

Stock holding and call-off service



For more products see page 49

## Wine and Beer



### Wine and Beer Airtac® Bags

Product Code	Description	Bundle Qty	Case Qty
326693	Single Wine Airtac	50	500
255428	Twin Wine Airtac	50	250
326695	Triple Wine Airtac	25	200
259468	Single Magnum Bottle Airtac	25	400
281104	Single Beer Bottle Airtac	50	500
255431	Triple Beer Bottle Airtac	25	250



Environmental impact rating See page 5



recycle with bags at large supermarkets  
DON'T RECYCLE AT HOME



recyclability category LDPE



minimum recycled content

### Wine and Beer Airtac® Boxes

Product Code	Description	Bundle Qty
254926	Single Wine Box Code	25
254933	Twin Wine Box Code	25
254935	Triple Wine Box Code	25
257624	Six Wine Box Code	25
257626	Twelve Wine Box Code	25
259473	Single Magnum Box Code	25
281405	Single Beer Box Code	50
257199	Triple Beer Box Code	25
257271	Six Beer Box Code	25
269615	Twelve Beer Box Code	25

### Wine and Beer Airtac® Kits - Bag & Box

Product Code	Description	Bundle Qty
327612	Kit for Single Wine Airtac and box	50
256043	Kit for Twin Wine Airtac and box	50
256048	Kit for Triple Wine Airtac and box	25
257711	Kit for Six Wine Airtac and box	25
257712	Kit for Twelve Wine Airtac and box	25
271763	Kit for Single Magnum Bottle Airtac and box	25
281105	Kit for Single Beer Airtac and box	50
257714	Kit for Triple Beer Airtac and box	25
257716	Kit for Six Beer Airtac and box	25
269786	Kit for Twelve Beer Airtac and box	25

### Boxes

Environmental impact rating See page 5



recycle



recyclability category PAP



minimum recycled content



# Protective

## Products

Bubble Wrap	44
Bubble Bags	47
BubbleMask™	48
BubbleGuard®	48
Airsac® Inflatable Packaging	49
Sealed Air Bubble Wrap® IB	54
Sealed Fill-Air	56
Korrvu® Select	57
Air Cushioning and Voidfill	60
Cell-Aire® Polythene Foam	62
Foam Cushioning and Voidfill	63
Instapak®	64
Geami WrapPak®	68
Paper Cushioning and Voidfill	69
Loosefill and Dispensers	74
Mesh Sleeving	75
Edge and Corner Protectors	76
Woodwool and Vermiculite	78



Protective



Pregis

Ranpak



Local service with national coverage

Wide product range

Next day delivery available

Stock holding and call-off service



# Protective



Speak to us about paper bubble

## AirCap® Bubble Wrap

The difference is in the barrier!

AirCap® – A better value bubble

**Reduced Costs:** less material is required compared to non-barrier brands.

**Longer Lasting Protection:** our full air bubble maintains consistent cushioning during storage and transit.

**Quality Assurance:** AirCap® is manufactured under ISO 9001:2008 guaranteeing high standards of production and quality control.

**Ideal for:** cushioning, surface protection, void filling, interleaving, blocking and bracing.

**Small bubble** is best suited for surface protection, defending your items against scratches and abrasions.

**Large bubble** is best suited for cushioning your products whilst in transit and storage.

**Extra large bubble** is best suited for void fill and large cushioning applications.





## Bubble Wrap

Available in the following combinations:

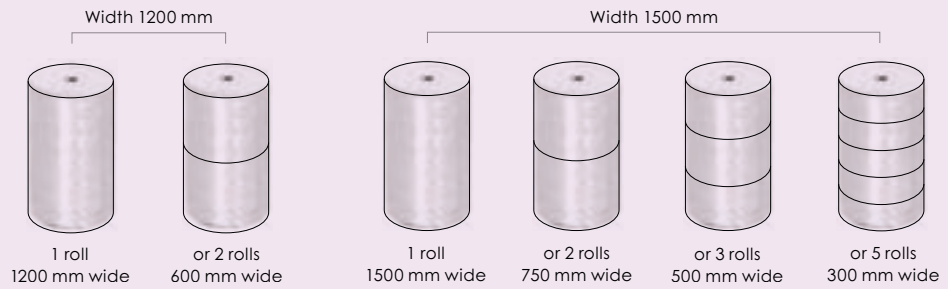

### Standard Small\*

Product Code	Roll Width (mm)	Length (m)	Bubble Height (mm)	Bubble Diameter (mm)	Pack Qty
2479EL	300	200	4.2	9.5	5 Rolls
2478EL	500	200	4.2	9.5	3 Rolls
2819EL	600	200	4.2	9.5	2 Rolls
2477EL	750	200	4.2	9.5	2 Rolls
2818EL	1200	200	4.2	9.5	1 Roll
2476EL	1500	200	4.2	9.5	1 Roll



Protective

### Standard Large\*

Product Code	Roll Width (mm)	Length (m)	Bubble Height (mm)	Bubble Diameter (mm)	Pack Qty
201629	300	50	8.6	18	5 Rolls
201628	500	50	8.6	18	3 Rolls
201622	750	50	8.6	18	2 Rolls
201618	1500	50	8.6	18	1 Roll

### Heavy Duty Small\*

Product Code	Roll Width (mm)	Length (m)	Bubble Height (mm)	Bubble Diameter (mm)	Pack Qty
000348	300	100	4.2	9.5	5 Rolls
000305	500	100	4.2	9.5	3 Rolls
000313	750	100	4.2	9.5	2 Rolls
000318	1500	100	4.2	9.5	1 Roll

### Standard Extra Large\*\*

Product Code	Roll Width (mm)	Length (m)	Bubble Height (mm)	Bubble Diameter (mm)	Pack Qty
000947	300	50	12.7	32	5 Rolls
000946	500	50	12.7	32	3 Rolls
000945	750	50	12.7	32	2 Rolls
140919	600	50	12.7	32	2 Rolls
005723	1200	50	12.7	32	1 Roll
000862	1500	50	12.7	32	1 Roll

#### Environmental impact rating See page 5

\*Standard Small, Standard Large, Heavy Duty Small \*\*Standard Extra Large



don't recycle



recyclability category  
OTHER



30% minimum\*  
recycled content



0% recycled\*\*  
content

Local service with national coverage

Wide product range

Next day delivery available

Stock holding and call-off service



## Anti-Static AirCap®

Compatible wrapping for electronic items

**Application for Anti-Static AirCap®:** protect sensitive electronic components from static electricity

**Supplied in un-perforated rolls:** allowing users to determine their bubble sheet size

**Easy to tear off:** designed to consistently tear with a tidy edge

### Anti-Static Small\*

Product Code	Bubble Size	Bubble Height (mm)	Bubble Dia. (mm)	Roll Width (mm)	Length (m)	No. of Rolls
000702	Small	4.2	9.5	300	100	5
000700	Small	4.2	9.5	500	100	3
000697	Small	4.2	9.5	750	100	2
000696	Small	4.2	9.5	1500	100	1

### Anti-Static Extra Large\*\*

Product Code	Bubble Size	Bubble Height (mm)	Bubble Dia. (mm)	Roll Width (mm)	Length (m)	No. of Rolls
002817	Extra Large	12.7	32	500	50	3
000353	Extra Large	12.7	32	600	50	2
001057	Extra Large	12.7	32	750	50	2
000351	Extra Large	12.7	32	1200	50	1
000352	Extra Large	12.7	32	1500	50	1

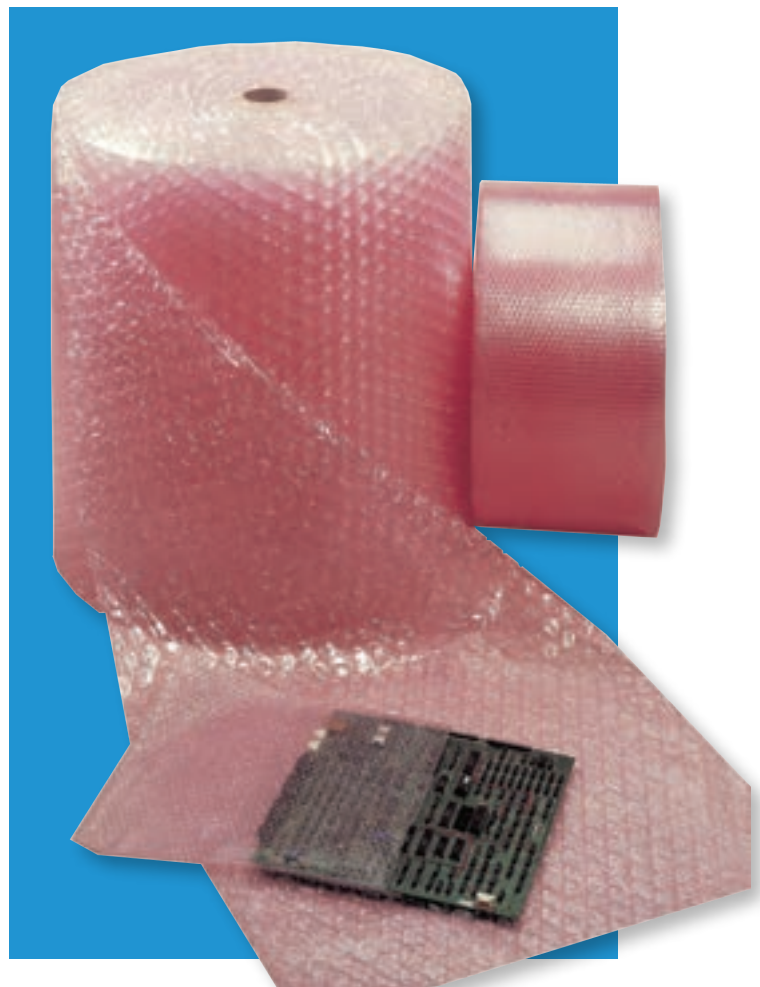

**Environmental impact rating** See page 5

\*Anti-Static Small\*\*Anti-Static Extra Large



don't recycle



recyclability category  
**OTHER**



30% less than\*  
recycled content



0% recycled\*\*  
content



## AirCap® Bubble Bags

Safe, secure packaging

**Cost effective:** Ready-made bubble bags

**Suitable for a wide variety of applications:**

Bubble bags can be customised to your requirements from small to large enough to take a car bumper

**Laminated bags:** For extra strength

**Ideal for:** Shipping and storage of fragile products

**Two Variants:** Available in both standard small bubble and anti-static small bubble



### Standard AirCap®\*

Product Code	Size Reference	Internal Size (mm)	Qty Per Carton
001348	BB1	100 x 135	750
000394	BB2	130 x 185	500
001346	BB3	180 x 235	300
001347	BB4	230 x 285	300
001349	BB5	280 x 360	150
000397	BB6	305 x 435	150
000401	BB7	380 x 435	100

### Anti-Static AirCap®\*\*

Product Code	Size Reference	Internal Size (mm)	Qty Per Carton
001378	ASBB1	100 x 135	750
001367	ASBB2	130 x 185	500
001379	ASBB3	180 x 235	300
001366	ASBB4	230 x 285	300
001365	ASBB5	280 x 360	150
000710	ASBB6	305 x 435	150
000626	ASBB7	380 x 435	100
002185	-	900 x 900	100



#### Environmental impact rating See page 5

\*Standard AirCap® \*\*Anti-Static AirCap®



don't forget...

Postal tubes  
SEE PAGE 36

Double wall boxes  
SEE PAGE 14

Polythene cutter  
SEE PAGE 132

Printed warning tapes  
SEE PAGE 95

Local service with national coverage

Wide product range

Next day delivery available

Stock holding and call-off service



## AirCap® BubbleMask™

An adhesive shield for fragile products

BubbleMask™ is self-adhesive bubble masking for surface protection, ensuring quick and easy application.

**Superior abrasion resistance for critical surfaces:** with BubbleMask™ you have all the protection of conventional masking, plus the proven performance of AirCap® bubble

**Saves time and money:** easy application, no need for expensive fixings and tapes. It is easily removed and re-used, with further savings in labour and materials

**Ideal for superior surface protection:** office furniture, kitchen/bathroom fittings, home appliances, sheet glass, marine equipment, vehicle body panels, televisions and computers monitors



Product Code	Bubble Size	Bubble Height (mm)	Bubble Diameter (mm)	Roll Width (mm)	Length (m)	No. of Rolls
000620	Small	4.2	9.5	300	100	5
001048	Small	4.2	9.5	500	100	3
001047	Small	4.2	9.5	750	100	2
001301	Small	4.2	9.5	1500	100	1

Environmental impact rating See page 5



don't recycle



recyclability category OTHER



minimum recycled content



## AirCap® BubbleGuard®

**Excellent surface protection:** The strong and soft polypropylene material offers excellent surface protection plus helps prevent moisture and condensation build up

**Better cushioning:** AirCap® Barrier Sealed Bubble for long-term cushioning performance

**Ideal for high value items:** for the furniture and removal industry

Product Code	Grade	Roll Width (mm)	Length (m)	Bubble Size	No. of Rolls
009874	Multi Purpose	1500	100	Small	1



Environmental impact rating See page 5



don't recycle



recyclability category OTHER



recycled content





## Airsac® inflatable packaging

**Airsac moulds itself around your products to provide maximum protection, so your goods reach their destinations in perfect condition.**

- Significantly reduces damages and returns
- Save up to 90% of your storage space - come flat until inflated
- Quick and easy to use
- Enhances your product and company image
- No expensive start-up costs or machinery required, just a small air compressor, air line or hand pump.
- Many standard size bags in stock - bespoke Airsac designs are also available
- Bespoke outer boxes in any size also available
- Many lines available in 50% recycled content material

## airsac Wine and Beer

### Wine and Beer Airsac® Bags

Product Code	Description	Bundle Qty	Case Qty
326693	Single Wine Airsac	50	500
255428	Twin Wine Airsac	50	250
326695	Triple Wine Airsac	25	200
259468	Single Magnum Bottle Airsac	25	400
281104	Single Beer Bottle Airsac	50	500
255431	Triple Beer Bottle Airsac	25	250



Environmental impact rating See page 5



recycle with bags at large supermarkets  
DON'T RECYCLE AT HOME



recyclability category LDPE



50% minimum recycled content

### Wine and Beer Airsac® Boxes

Product Code	Description	Bundle Qty
254926	Single Wine Box Code	25
254933	Twin Wine Box Code	25
254935	Triple Wine Box Code	25
257624	Six Wine Box Code	25
257626	Twelve Wine Box Code	25
259473	Single Magnum Box Code	25
281405	Single Beer Box Code	50
257199	Triple Beer Box Code	25
257271	Six Beer Box Code	25
269615	Twelve Beer Box Code	25

### Wine and Beer Airsac® Kits - Bag & Box

Product Code	Description	Bundle Qty
327612	Kit for Single Wine Airsac and box	50
256043	Kit for Twin Wine Airsac and box	50
256048	Kit for Triple Wine Airsac and box	25
257711	Kit for Six Wine Airsac and box	25
257712	Kit for Twelve Wine Airsac and box	25
271763	Kit for Single Magnum Bottle Airsac and box	25
281105	Kit for Single Beer Airsac and box	50
257714	Kit for Triple Beer Airsac and box	25
257716	Kit for Six Beer Airsac and box	25
269786	Kit for Twelve Beer Airsac and box	25

#### Boxes

Environmental impact rating See page 5



recycle



recyclability category PAP



50% minimum recycled content

Local service with national coverage

Wide product range

Next day delivery available

Stock holding and call-off service





Custom  
printing  
available  
Call us

## Electronics

### Electronics Airsac® Bags

Product Code	Description	Bundle Qty	Case Qty
255412	Large Mobile Phone Airsac*	50	1000
255008	Hard Disk Drive Airsac*	50	1000
254993	7" Tablet Airsac	50	1000
254995	10" Tablet Airsac*	50	500
294092	13.5" Laptop Airsac*	50	300
326696	15" Laptop Airsac*	25	200
254135	18" Laptop Airsac	25	150
254991	PC Base Unit End Caps (1 unit - 1 end cap)	25	250
255004	28" TV Airsac Top Cap Airsac*	25	150
255003	28" TV Airsac Bottom Cap Airsac*	25	150
261847	32" TV Airsac End Caps (1 unit - 1 end cap)	25	175
261849	40-42" TV Airsac End Caps (1 unit - 1 end cap)	25	100
261851	47-50" TV Airsac End Caps (1 unit - 1 end cap)	25	75
281111	55-65" TV Airsac End Caps (1 unit - 1 end cap)	25	75
290978	X Box	50	200
269664	PS4*	50	200



Product Code: 291897

### Electronics Airsac® Boxes

Product Code	Description	Bundle Qty
254923	Large Mobile Phone Box	50
269619	Hard Disk Drive Box	50
254989	7" Tablet Box	50
254990	10" Tablet Box	50
294094	13.5" Laptop Box	50
254988	15" Laptop Box	25
254894	18" Laptop Box	25
255433	PC Base and Monitor Box	10
263007	PC Base only Box	15
255634	28" TV and iMac Box	10
276131	32" TV Box	10
276146	40-42" TV Box	10
260579	47-50" TV Box	10
272533	55-65" TV Box	10
296586	X Box Box	50



Product Code: 254991

don't  
forget...

SEE PAGE  
98

Tape dispenser

SEE PAGE  
12

Single wall boxes

SEE PAGE  
33

Paper document wallets

SEE PAGE  
132

Packing opener



## Electronics



Product Code: 256070

### Electronic Airsac® Kits- Bag and Box

Product Code	Description	Bundle Qty
291894	Kit for Hard Disk Drive Airsac and Box	50
256055	Kit for Large Mobile Phone Airsac and Box	50
256062	Kit for 7" Tablet Airsac and Box	50
256064	Kit for 10" Tablet Airsac and Box	50
294105	13.5" Laptop Airsac and Box	50
256066	Kit for 15" Laptop Airsac and Box	25
256070	Kit for 18" Laptop Airsac and Box	25
269768	Kit for PC Base and Monitor Airsac and Box	50
256485	Kit for PC Base only Airsac and Box	50
256487	Kit for 28" TV and iMac Top and Bottom Airsac and Box	50
271756	Kit for 32" TV Airsac and Box	10
271754	Kit for 40-42" TV Airsac and Box	10
271758	Kit for 47-50" TV Airsac and Box	10
281112	Kit for 55-65" TV Airsac and Box	10
296583	X Box Airsac and Box	25



## Pharmacy

### Pharmacy Airsac® Bags

Product Code	Description	Bundle Qty	Case Qty
255418	Medium Bottle Airsac (250ml)	50	1000
255422	Large Bottle Airsac (500ml)	50	500

### Pharmacy Airsac® Boxes

Product Code	Description	Bundle Qty
254985	Medium Bottle Box	50
254922	Large Bottle Box	50

### Pharmacy Airsac® Kit - Containing Airsac Bag and Box

Product Code	Description	Bundle Qty
256051	Medium Bottle Airsac and Box	50
256054	Large Bottle Airsac and Box	50



Product Code: 256051



Product Code: 255418



Product Code: 255422



Protective

### Bags

Environmental impact rating See page 5



recycle with bags at large supermarkets  
DON'T RECYCLE AT HOME



recyclability category LDPE



30% minimum recycled content\*



0% recycled content

### Boxes

Environmental impact rating See page 5



recycle



recyclability category PAP



50% minimum recycled content

Local service with national coverage

Wide product range

Next day delivery available

Stock holding and call-off service

## airsac® Jars and Mugs

Product Code	Description	Bundle Qty	Case Qty
269620	Jam Jar 1	50	1200
273323	Jam Jar 2	50	1100
300700	Mug	50	50



Environmental impact rating See page 5



recycle with bags at large supermarkets  
DON'T RECYCLE AT HOME



recyclability category  
LDPE



0% recycled content

## airsac® Frames

Product Code	Description	Bundle Qty	Case Qty
269769	Picture Frame Corners 1	100	300
269771	Picture Frame Corners 2	100	650



Environmental impact rating See page 5



recycle with bags at large supermarkets  
DON'T RECYCLE AT HOME



recyclability category  
LDPE



0% recycled content

## airsac® Tins

Product Code	Description	Bundle Qty	Case Qty
281167	5 Ltr	50	250
281407	2.5 Ltr	50	500



Environmental impact rating See page 5



recycle with bags at large supermarkets  
DON'T RECYCLE AT HOME



recyclability category  
LDPE



0% recycled content

# airsac Roll and Inflation Tools

Product Code	Description	Pack Qty
255408	Airsac on a Roll, 440mm x 250m, creased every 30mm	1
251417	Airsac Oil Free Compressor, Hose and Trigger Gun	1
255642	Hand Air Pump	1
260095	Bench Buddy - Foot Pedal, Nozzle and Tubing	1
286366	500mm x 250 mtr Bubble	1
293843	800mm x 250 mtr Bubble	1
286369	1000mm x 125 mtr Bubble	1
286371	1200mm x 125 mtr Bubble	1



Local service with national coverage

Wide product range

Next day delivery available

Stock holding and call-off service







Call for demo and pack cost comparison

## NewAir I.B.® Flex™

### Increase throughput, small footprint

The NewAir I.B.® Flex™ inflatable cushioning system produces NewAir I.B.® and Bubble Wrap® IB materials at speeds up to 90 linear feet per minute. Faster inflation of packing material makes lines more productive, employees more efficient and gets more products out the door on time. The NewAir I.B.® Flex™ System has a compact footprint (less than 6 sq. ft) that works well in cellular packaging environments.

### Maximum inflation reduces excess material up to 50%

Patented technology maximizes the inflation in every cell to reduce the amount of material needed to provide superior damage protection.

### Unmatched reliability

Delays in production can slow down productivity. With the NewAir I.B.® Flex™, limit the potential for throughput loss.

Components are manufactured with high performance materials and coatings for long life system reliability.

### System accessories for every configuration

The NewAir I.B.® Flex™ is supported by a large array of system accessories, making it flexible enough to be used in all packaging operations. NewAir I.B.® Flex™ is fast enough to keep up with the most demanding packaging operations.



## Bubble Wrap IB® Pouch

Product Code	Description	Inflated Bubble Size (mm)	Bag Size (mm) Uninflated	Metres Per Roll	Number of Bags Per Roll	Pallet Qty
282390	Medium Premium	13	200 x 300	373	1340	1338
282389	Large Regular	19	200 x 300	297	1060	1082
282383	Large Premium	19	200 x 300	221	800	804
282385	Large Premium	19	430 x 300	221	441	402
282387	Large Premium	19	200 x 150	221	800	804



Environmental impact rating See page 5



don't recycle



recyclability category  
OTHER



0% recycled content



## NewAir I.B.® and Bubble Wrap IB® Film

Product Code	Description	Inflated Bubble Size (mm)	Uninflated Sheet Size (mm)	Metres Per Roll	Pallet Qty
275809	Small Regular	6	400 x 160	1006	24
275811	Small Regular	6	400 x 320	1006	24
275814	Small Regular	6	800 x 160	1006	12
275815	Small Regular	6	800 x 320	1006	12
282101	Medium Premium	13	400 x 160	762	24
007020	Medium Premium	13	400 x 320	762	24
007021	Medium Premium	13	800 x 320	762	12
007022	Large Premium	19	400 x 320	457	24
007023	Large Premium	19	800 x 320	457	12
271357	Large Quilt	45	400 x 90	610	24
282102	Standard Extreme IB XL	25	400 x 300	366	24
282104	Standard Extreme Large Quilt	40	400 x 90	366	24
007024	Extra Large Premium	25	400 x 320	427	24
007025	Extra Large Premium	25	800 x 320	427	12
271352	Medium Regular	13	400 x 320	1006	24
271356	Medium Regular	13	800 x 320	1006	12
007026	Large Regular	19	400 x 320	610	24
007027	Large Regular	19	800 x 320	610	12
271359	Large Regular Short Perforation	19	400 x 160	610	24
007028	Extra Large Regular	25	400 x 320	579	24
007029	Extra Large Regular	25	800 x 320	579	12
247427	Large Anti Static	19	400 x 320	457	24
260489	Large Premium Anti Static	19	800 x 320	457	12



Protective

Environmental impact rating See page 5

don't  
recyclerecyclability  
category  
OTHER0%  
recycled  
contentNewAir I.B.® and Bubble Wrap IB®  
30% Recycled Content Film

Product Code	Description	Inflated Bubble Size (mm)	Uninflated Sheet Size (mm)	Metres Per Roll	Pallet Qty
328981	Medium Regular Perf at 320mm	13	400 x 320	1006	24
329193	Medium Regular Perf at 320mm	13	800 x 320	1006	12
329194	Large Regular Perf at 320mm	19	400 x 320	610	24
329234	Large Regular Perf at 320mm	19	800 x 320	610	12
329232	Xtra Large Regular Perf at 320mm	25	400 x 320	579	24
329235	Xtra Large Regular Perf at 320mm	25	800 x 320	579	12



Environmental impact rating See page 5

don't  
recyclerecyclability  
category  
OTHER30%  
minimum  
recycled  
contentLocal service with  
national coverage

Wide product range

Next day delivery  
availableStock holding and  
call-off service



Call for demo and pack cost comparison

## Fill-Air Rocket®

Our Fastest Inflatable Void Fill System

The Fill-Air Rocket® inflatable void fill system, a void fill solution designed specifically to meet the needs of modern fulfillment. Drawing on decades of best-in-class inflatable void fill experience, the Fill-Air Rocket® system is faster, simpler, lighter and better prepared for your packaging operations.



### Fill-Air Extreme Efficiency® Films

Product Code	Description	Bag Size (mm)	Pallet Qty
248215	Fill Air Extreme Efficiency®	200mm x 130mm x 1799m	48
237898	Fill Air Extreme Efficiency®	200mm x 200mm x 1799m	48
260511	Fill Air Extreme Efficiency®	250mm x 130mm x 1799m	36
260512	Fill Air Extreme Efficiency®	250mm x 200mm x 1799m	36
260562	Fill Air Extreme Efficiency®	300mm x 130mm x 1799m	36
236028	Fill Air Extreme Efficiency®	300mm x 200mm x 1799m	36
235911	Rocket Machine		
271254	AirWrap 75	200mm x 75mm x 1280m	36
282797	AirWrap 75	250mm x 75mm x 1280m	36
278548	AirWrap 75	300mm x 75mm x 1280m	36

Environmental impact rating See page 5



don't recycle



recyclability category HDPE



0% recycled content



For more information Contact us

## Fill-Air® RF

**Fast and easy use:** With minimal training, the operator can easily insert the inflator nozzle into the extended valve for top void fill applications.

**Flexibility for maximum efficiency and productivity:**

The portable inflator can be set up anywhere.

**Versatility:** Bags available in seven sizes for a wide variety of applications.

**Reduced storage and handling cost:** Bags are shipped flat and inflated when used.

**Application:** Ideal for void fill applications electrical, electronic, and computer parts, office products, box in box shipments, retailers, handbag and holdall manufacturers.

Product Code: 000108



### Fill-Air® RF Bags

Product Code	Bag Size (mm)	Reference	Pack Qty
003767	230 x 280	RF1	250
003768	280 x 380	RF2	250
003769	360 x 460	RF3	250
003770	410 x 530	RF4	250
003771	460 x 580	RF5	250
003772	490 x 910	RF6	125
003773	910 x 1070	RF7	100

Environmental impact rating See page 5



don't recycle



recyclability category HDPE



0% recycled content

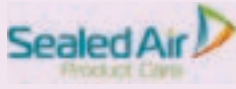

## Korrvu® Select

Reduces the need for additional void filling or wrapping  
A fast, effective, high performance solution

Korrvu® Select packaging provides proven product protection and maximum versatility in a comprehensive range of sizes and easy to use designs that offers a fast, effective, high performance solution that meets the packaging demands of a variety of products and packaging applications.

Korrvu® Select packaging offers the potential for source reduction and eliminates the need for additional void filling or wrapping. It is a dynamic packaging product that uses a strong, highly-resilient low-slip film to surround your products, protecting them from shock and vibration by ensuring your product holds centre place inside the box.



## Korrvu® Retention Frame

Cost-effective blocking and bracing protection

Providing shock protection during the shipping cycle, Korrvu® Retention packaging provides cost-effective blocking and bracing protection whilst holding your product securely within its retention frame.



Product Code	Reference	Description	Size (mm)	Pack Qty	Maximum Product Weight (Kgs)
260572	KS-RP-01	Regular Korrvu® Film	465 X 600	25	3.00
260672		Premium Korrvu® Film	465 X 600	25	4.00
260409		Box	568 X 365 X 110	50	
260684	KS-RP-02	Regular Korrvu® Film	392 X 497	25	3.00
260686		Premium Korrvu® Film	392 X 497	25	4.00
260663		Box	392 X 292 X 230	25	

Insert (including the film) can be recycled as film is less than 5% in weight of the insert

Environmental impact rating See page 5



recycle



recyclability category  
FAP



30% minimum recycled content

Local service with national coverage

Wide product range

Next day delivery available

Stock holding and call-off service



## Korrvu® Retention box

A simple and attractive solution

All the benefits of Korrvu® Retention packaging within an innovative all-in-one box design that is ready to ship. Korrvu® Retention boxes allow you to showcase your products with excellent visibility and display. The flexible retention film accommodates a wide variety of spare parts and accessories.



Product Code	Reference	Description	Size (mm)	Pack Qty	Max Product Weight (Kgs)
260712	KS-RB-11	Regular Korrvu® Film	700 X 340	50	0.30
260713		Premium Korrvu® Film	700 X 340	50	0.50
260714	KS-RB-12	Regular Korrvu® Film	513 X 336	50	0.30
260715		AntiStatic Korrvu® Film	513 X 336	50	0.50
260716	KS-RB-13	Regular Korrvu® Film	669 X 420	50	0.30
260717		AntiStatic Korrvu® Film	669 X 420	50	0.50
260718	KS-RB-14	Regular Korrvu® Film	1091 X 537	25	1.00
260720		AntiStatic Korrvu® Film	1091 X 537	25	1.50
260722	KS-RB-15	Regular Korrvu® Film	870 X 460	50	0.50
260723		Premium Korrvu® Film	870 X 460	50	0.75
260724	KS-RB-16	Premium Korrvu® Film	423 X 397	50	0.30
260725	KS-RB-17	Premium Korrvu® Film	793 X 517	50	0.60

Insert (including the film) can be recycled as film is less than 5% in weight of the insert

Environmental impact rating See page 5





## Korrvu® Bottle Packs

Korrvu® Bottle Packs provide superior product protection by holding product securely in place with strong, highly resilient low-slip film protecting them from shock and vibration

Korrvu® Bottle Packs not only protect but attractively showcase product enhancing customer experience.

Product Code	Reference	Insert/inbox (mm)	Max product weight (kg)
282116	KS-RP-07 Regular	490 x 281	-
282139	KS-RP-07 Box 1	365 x 111 x 100	1.5
282141	KS-RP-07 Box 2	365 x 222 x 100	3.0
282142	KS-RP-07 Box 3	365 x 333 x 100	4.5



Insert (including the film) can be recycled as film is less than 5% in weight of the insert

Environmental impact rating See page 5



Protective



## Korrvu® Suspension

Consistent protection for fragile products

Using two layers of highly resilient low-slip film, Korrvu® Suspension packaging suspends your product in the air space of the container, providing consistent protection, throughout the shipping cycle, for fragile products, even after repeated drops.



Product Code	Reference	Description	Size (mm)	Pack Qty	Max Product Weight (Kgs)
260726	KS-SP-21	Regular Korrvu® Film	360 X 268	25	1.00
260701		Box	194 X 194 X 86	25	
260727	KS-SP-22	Regular Korrvu® Film	460 X 318	25	2.50
260707		Box	294 X 194 X 136	25	
260728	KS-SP-23	Regular Korrvu® Film	639 X 455	50	5.00
260663		Box	392 X 292 X 230	20	
260730	KS-SP-24	Regular Korrvu® Film	601 X 230	25	0.50
260731		Box	235 X 165 X 75	50	
260732	KS-SP-25	Regular Korrvu® Film	1280 X 935	10	14.00
260733		Box	788 X 626 X 242	10	

Insert (including the film) can be recycled as film is less than 5% in weight of the insert

Environmental impact rating See page 5



Local service with national coverage

Wide product range

Next day delivery available

Stock holding and call-off service





## MINI PAK'R® MACHINE AND RENEW FILM

### Air Cushion Machine

Are you looking to protect your goods during transportation? MINI PAK'R® is a small, easy to use system that allows you to produce air cushions on demand. You can choose different types of air cushions, for any kind of protection you need.

#### Easy to use

Plug in the machine, load the film and it is ready to go. The machine uses an internal air source, no compressed air is needed.

#### Latest technology

Uses RFID (Radio Frequency Identification) technology to automatically select the correct settings for ease of use.

#### Versatile

At a speed of 7,5 metres/minute the machine makes different types of air cushions that fit a variety of packaging applications.

#### Space saving

Machine is compact (LxWxH=36x33x28cm), weighs only 6 kg, and fits almost anywhere.

#### Smart accessories

The MINI PAK'R® can be combined with a range of accessories to make the packaging process even more efficient. Some of the accessories are the Top Fill and the Mobile Fill which allow cushions to be produced on demand.

TABLE 1 - MINI PAK'R® Renew 30% Recycled content film\*

Product Code	Description	Size (mm x mm)	Metres Per Roll
315758	MINI PAK'R® V2 & V3 Renew Double Cushion	400 x 150	375
331668	MINI PAK'R® V2 Renew Double Cushion LD 3.5	400 x 150	250
327866	MINI PAK'R® V2 Renew Quilt Large LD 3.5	400 x 150	250
328464	MINI PAK'R® V2 Renew Quilt Small LD 3.5	400 x 150	250
328075	MINI PAK'R® V2 Renew Supertube LD 3.5	400 x 150	250
327867	MINI PAK'R® V2 Renew 200 x 130mm HD 2.3	200 x 130	425
321543	MINI PAK'R® V3 Renew Quilt Large	400 x 150	375
315758	MINI PAK'R® V3 Renew Double Cushion	400 x 150	375
321799	MINI PAK'R® V3 Renew Zero	200 x 130	515

TABLE 2 - MINI PAK'R® Renew 50% Recycled content film\*\*

Product Code	Description	Size (mm x mm)	Metres Per Roll
315283	MINI PAK'R® V3 Renew	200 x 130	515
315285	MINI PAK'R® V3 Renew	200 x 200	515



#### MINI PAK'R® INDUSTRIAL

Are you a larger user looking for an industrial solution, flexibility and service?

#### Conditions:

- Machine is placed free of charge (a contract MUST be signed, the machine will remain property of Pregis)
- Minimum monthly usage should be 10 rolls per month
- Delivery of full pallets only

(\*\*\*) The Pillow Pak film requires an extension arm on the MINI PAK'R®, call us.

Environmental impact rating See page 5

\*Table 1 Products \*\*Table 2 Products



recycle with bags at large supermarkets  
DON'T RECYCLE AT HOME



recyclability category  
LDPE



30% minimum recycled content



50% minimum recycled content



# PRO PAK'R®

## Air Cushion Machine

### Reliability and efficiency

- One machine can run the complete range of films
- User lockout capability: adjust only specified settings
- Fast machine: produces up to 21 meters of cushions per minute
- Designed for industrial use: 24/7

### High technology

- Radio Frequency Identification (RFID) allows the machine to recognize the film type and adjust its settings accordingly
- History storage (consumption and operator usage tracking)
- Auto-Index Feature- for automatic replenishment of air cushions directly to the packer

### Innovative accessories

The PRO PAK'R® can be integrated to enhance your packing process as well as being compatible with a number of accessories.

### Easy maintenance

No Teflon belts reduces downtime and the 2/48 policy from Pregis will assist in case of problem: we will call you back within 2 hours and solve the problem within 48 hours. One machine can serve multiple pack stations.



TABLE 1 - PRO PAK'R® Renew 5% Recycled content film\*

Product Code	Description	Size (mm x mm)	Metres Per Roll
260676	PRO PAK'R® Double Cushion	460 x 150	475
331671	PRO PAK'R® Quilt Large	379 X 150	457
278617	PRO PAK'R® Pillow Pak	705 x 185	200
331331	PRO PAK'R® Multitube	400 x 127	665

TABLE 2 - PRO PAK'R® Renew 50% Recycled content film\*\*

Product Code	Description	Size (mm x mm)	Metres Per Roll
315287	PRO PAK'R® Renew	200 x 130	1100
312112	PRO PAK'R® Renew	200 x 200	1100



### Environmental impact rating See page 5

\*Table 1 Products \*\*Table 2 Products



recycle with bags at large supermarkets  
DON'T RECYCLE AT HOME



recyclability category  
LDPE



30% minimum\* recycled content



50% minimum\*\* recycled content

Local service with national coverage

Wide product range

Next day delivery available

Stock holding and call-off service



For more information  
Contact us

## Cell-Aire®

### Polyethylene Foam

Cell-Aire® polyethylene foam provides superior protection, allowing for fewer wraps or for the use of thinner material.

Cell-Aire® is made of low-density polyethylene,

An alternative product to corrugate roll:

- Versatile and cost-effective
- Clean, non-abrasive and lightweight
- Resistant to moisture damage
- Excellent thermal insulation
- Dust free
- Not recyclable
- Wide range of thickness's available – from 0.7mm to 4mm
- Ideal for surface protection

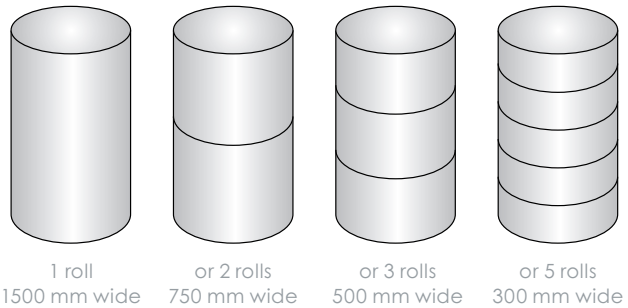

Product Code	Thickness (mm)	Roll Width (mm)	Roll Length (m)	Pack Quantity
001547	0.7	1500	300	1 Roll
001546	0.7	1000	300	1 Roll
001545	0.7	750	300	2 Rolls
001544	0.7	500	300	3 Rolls
001543	0.7	300	300	5 Rolls
000957	1	1500	300	1 Roll
000956	1	1000	300	1 Roll
000955	1	750	300	2 Rolls
000954	1	500	300	3 Rolls
000953	1	300	300	5 Rolls
000962	1.5	1500	200	1 Roll
000961	1.5	1000	200	1 Roll
000960	1.5	750	200	2 Rolls
000959	1.5	500	200	3 Rolls
000958	1.5	300	200	5 Rolls
000967	2.5	1500	120	1 Roll
000966	2.5	1000	120	1 Roll
002485	2.5	750	120	2 Rolls
000964	2.5	500	120	3 Rolls
000963	2.5	300	120	5 Rolls
000973	4	1500	75	1 Roll
000972	4	1000	75	1 Roll
000795	4	750	75	2 Rolls
000969	4	500	75	3 Rolls
000968	4	300	75	5 Rolls

Environmental impact rating See page 5



don't  
recycle



recyclability  
category  
**OTHER**



0%  
recycled  
content



For more information  
Contact us

## SpeedyPacker Insight®

The SpeedyPacker Insight® system delivers cost effective, superior product protection and presents your product to your customers in an attractive, damage-free package.

**Fast:** deliver up to 21 foam-filled bags per minute, providing maximum productivity and product protection at the touch of a button

**Moulded and engineered cushions:** create moulded cushions for products that require a consistent, precise fit and superior product protection

**High volume applications**

**Versatile and efficient:** dedicate a system to one packaging line or multiple packing lines

**New touch screen:** user friendly



Protective



## Instapak iMold®

The Proven Performance of Instapak® Cushioning in a Revolutionary Automated System.

The fully automated Instapak iMold® system creates engineered, pre-moulded Instapak® foam cushions for immediate use or to be transferred into storage bins for batching applications.

**Consistent protection:** guarantees cushion consistency and integrity by dispensing Instapak® foam where it's needed most, while eliminating material waste

**Affordable automation**

**Reduce labour cost**

**User friendly design** and touch screen interface is easy to use



Environmental impact rating See page 5



don't recycle



recyclability category  
**OTHER**



0% recycled content

Local service with national coverage

Wide product range

Next day delivery available

Stock holding and call-off service





## Instapak FoamWrap™ Express

The Instapak FoamWrap™ Express foam packaging system from Sealed Air® creates Instapak FoamWrap™ material for a variety of packaging applications. The system uses a range of Instapak® high performance packaging foams that provide superior protection with minimal foam usage. A compact design, customizable programming and just-in-time accumulation capability makes the Instapak FoamWrap™ Express system a perfect fit for any size packaging operation.



Environmental impact rating See page 5



don't  
recycle



recyclability  
category  
OTHER



0%  
recycled  
content



## Instapak® Simple™

The Instapak® Simple™ system is true to its name and is the easiest to use foam-in-bag platform yet. The system merges the premium performance of Instapak® foam packaging with an on-demand delivery system that requires minimal operator training and service.

The Instapak® Simple™ system is small and can be easily transferred to remote packaging locations, making it ideal for operations producing less than 20 packs per day.

**Versatility** – suitable for packing a vast range of products

**Just-in-time** – foam is expanded on site ensuring the right amount of material is used every time

**Product protection** – superior cushioning abilities that provide maximum protection with the minimum amount of material

**Space saving** – saving valuable warehouse space



Environmental impact rating See page 5



don't  
recycle



recyclability  
category  
OTHER



0%  
recycled  
content





# Instapacker® Tabletop™

The Instapacker® Tabletop™ system provides affordable foam packaging that combines proven reliability with the convenience and cost-effectiveness of the foam-in-bag process. The easy-to-use Instapacker® Tabletop system has an incredibly small footprint but can make a big impact on your shipping operations. Capable of producing up to 16 Instapak® foam-filled bags per minute, this versatile system can support the packaging needs of medium to high volume shipping operations, multiple pack station operations and even the production floor.

**Maximum value** – This inexpensive, foam-in-bag system reduces material and labour costs.

**Easy to use** – A simple touch key control panel virtually eliminates the operator’s learning curve.

**Compact** – Small, innovative design saves valuable workspace.

**Flexible** – The Instapacker™ Tabletop system supports the packaging needs of shipping rooms, multiple pack station operations and even the production floor.

**Protective** – Instapak® high-performance packaging foam is designed to protect your products during shipping, warehousing and general handling.



Environmental impact rating See page 5



don't  
recycle



recyclability  
category  
**OTHER**



0%  
recycled  
content

Local service with  
national coverage

Wide product range

Next day delivery  
available

Stock holding and  
call-off service



# Instapak® Quick RT®

Instapak® Quick RT® foam packaging, provides users with a custom-fit protective cushion that is fast, easy-to-use and ideal for small-to-medium volume packaging:

Convenient, portable, protective foam cushions... anywhere instantly

**Easy-to-Use:**

Anyone can become a packaging expert – instantly.

**Superior Product Protection:**

Virtually eliminate shipping damage..

**No system costs:**

No installation or service required

**Space saving packaging:**

Expand up to 27 times its original volume

**Versatile:**

Protects products of almost any size, shape and weight.

**Fast:**

Expands in seconds to form custom-fit protective foam cushions.

**Convenient:**

Takes up little space and is completely mobile so you can use it anywhere.

**Customer Satisfaction:**

Product arrives in a neat professional package

**Applications:**

Including Internet-based businesses, galleries, independent business owners, pack-and-ship stores, warranty repair depots, moving and storage facilities, retail shipping departments and mailrooms.

Product Code	Ref	Type	Size (mm)	Pack Qty
006387	10	RT	380 x 460	36
006388	20	RT	460 x 460	36
220989	40	RT	460 x 610	30
006389	60	RT	460 x 610	30
006390	80	RT	540 x 680	24
220987	100	RT	640 x 690	24

## Instapak Quick® RT

protective foam packaging can be activated right out of the box and requires no additional equipment.

# 3 simple steps

1 Press hard on the component 'A' oval to break the seal



2 Alternately 'pat' back and forth on the 'A' and 'B' ovals.



3 Nestle the product into the rising foam. Repeat the process.



Environmental impact rating See page 5



don't  
recycle



recyclability  
category  
OTHER



0%  
recycled  
content



## Instapak® Quick Tuff® RT®

Higher density foam providing durable cushioning and blocking and bracing protection for heavier products.

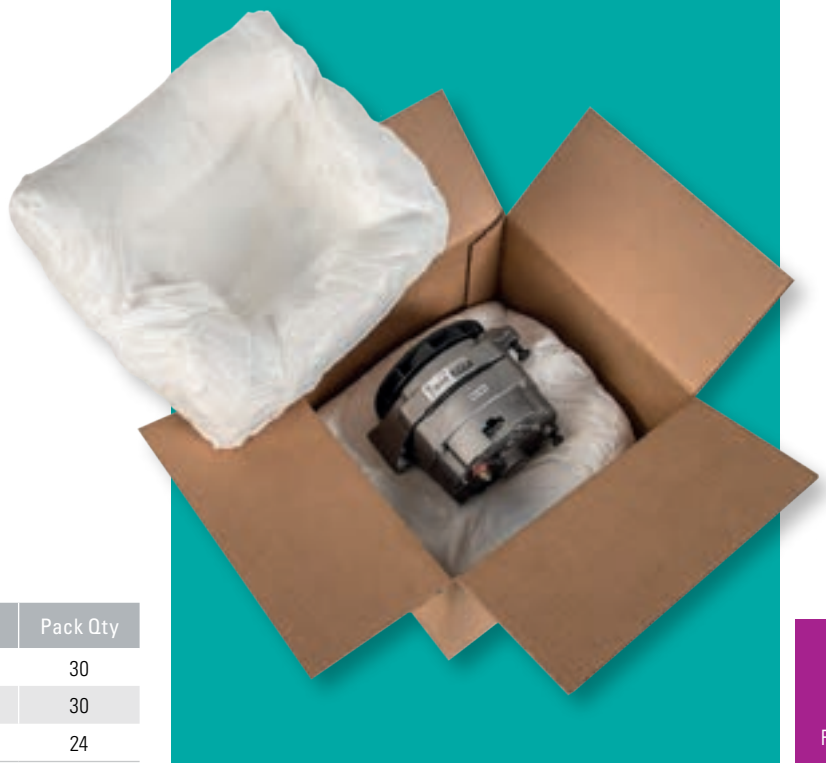

Product Code	Ref	Type	Size (mm)	Pack Qty
220993	25	Tuff RT	460 x 610	30
220996	45	Tuff RT	460 x 510	30
220998	65	Tuff RT	560 x 510	24



Protective

Environmental impact rating See page 5



don't  
recycle



recyclability  
category  
**OTHER**



0%  
recycled  
content



## Instapak® Quick RT® Starter Kit

Instapak® Quick® Starter Kit includes:

- 18 Instapak Quick® RT bags in nine different sizes and two different densities ranging from 38cm by 46cm to 54cm by 68cm.
- A user's guide
- Instructional DVD
- Safety glasses

Product  
Code:  
006391



Environmental impact rating See page 5



don't  
recycle



recyclability  
category  
**OTHER**



0%  
recycled  
content

Local service with  
national coverage

Wide product range

Next day delivery  
available

Stock holding and  
call-off service

## Ranpak® Geami WrapPak®

Wrap your products for a perfect presentation

Geami WrapPak® is the combination of a die cut Kraft paper with a tissue interleaf paper. The Geami WrapPak® HV converter expands the die cut paper to a 3D honeycomb structure providing a unique wrapping product.



Different colours available

Product Code	Kit Contains
255502	2 rolls of 000800 & 1 roll of 000802
255514	2 rolls of 000801 & 1 roll of 000802

Product Code	Type	GSM	Ply	Description	Width (mm)	Usable Length (m)	True Length (m)	Pack Qty	Pallet Qty	Weight (kg)
271513	Roll	80	Roll	Brown WrapPak®	508	250	420	1	40	10
271514	Roll	80	Roll	White WrapPak®	508	250	420	1	40	10
271515	Roll	22	Roll	White interleaf	305	840	840	1	20	5.5

## Ranpak® Geami Wrap 'n Go™

The modular set-up of our Geami Wrap 'n Go™ dispenser means you can choose wall-mounted or table top set-up. It can also be used with or without a the tissue interleaf



Product Code	Type	GSM	Ply	Description	Width (mm)	Usable Length (m)	True Length (m)	Pack Qty	Pallet Qty	Weight (kg)
323660	Roll	80	Roll	Brown Die-cut paper	508	55	134	1	60	3.4
323661	Roll	22	Roll	White interleaf	305	55	134	1	60	1
323662	Roll	80	Roll	Brown Die-cut paper	508	108	268	1	30	6.7
323663	Roll	22	Roll	White interleaf	305	108	268	1	30	2

Environmental impact rating See page 5





## Ranpak® FillPak® M

### Manual, easy to use void fill system

Compact and lightweight, the FillPak® M is the ideal choice for non-industrial environments.

Designed for manual use, this handy machine involves no knife or cutting mechanism. Instead a simple controlled tear is generated at the fanfold perforation. Manual users simply pull the required length of packaging and tear off.

Weight 4kg.



Product Code:  
004705

## Ranpak® FillPak® TT

### Fast and flexible for individual pack stations

Dispensing up to 1.4m of paper per second, the FillPak® TT accomplishes tasks comparable with bigger, weightier machines.

Light and compact this handy machine can be powered by battery where no electricity supply is available.

The FillPak® TT involves no cutting. A simple controlled tear is generated at the fanfold perforation. Height adjustable and also available with table clamp or floor stand.

Weight 7.5kg.



Protective

## Ranpak® FillPak® TT with cutter

### Compact choice for effortless void filling on-demand

The TT Cutter has all the benefits of the standard TT but with an automatic cut mechanism which makes it very appropriate for packing environments where there is a focus on ergonomics.

- User friendly – increased comfort for packer
- High output – 1.4m/sec converting speed
- EDS functionality – pre-set paper lengths
- Foot pedal option available



## Ranpak® FillPak® SL

The FillPak® SL paper system helps improve throughput and efficiency while reducing cost per parcel and minimizing impact on the environment. The FillPak® SL allows the operator to fill packaging quickly and effectively while maintaining sole focus on the filling process. Control options allow the operator to fill each box with a convenient and consistent flow of paper.



Local service with national coverage

Wide product range

Next day delivery available

Stock holding and call-off service



## Ranpak® FillPak® SL

The fastest end of line solution for filling boxes in high volume packing operations

FillPak® runs at high speed (1.4 m/sec) using paper with a width of 76cm. This solution reduces the time needed for filling boxes offering maximum box throughput and an efficient packing process.

**On demand:** paper dispensed at point of operation

**High speed:** converts at 1.4m/sec

**Simple to operate:** allows operator to focus on filling process

**Minimal downtime:** up to 5 paper packs can be glued together for continuous operation



## Ranpak® FillPak® Fanfold Paper

For use with FillPak® M, FillPak® TT and FillPak® TT with Cutter

An effective, economic and environmentally friendly void fill solution. Perforated every 186mm.



### FillPak® Fanfold Paper - Greenline

Product Code	Type	GSM	Ply	Colour	Width (mm)	Length (m)	Pack Qty	Pallet Qty	Weight (kg)
288732	Fanfold Greenline	70	1	Brown	381	360	1	48	10
920	Fanfold Greenline	50	1	Brown	762	500	1	24	20

Environmental impact rating See page 5



recycle



recyclability category  
FAP



100% recycled content

### FillPak® Fanfold Paper - Recycled Kraft

Product Code	Type	GSM	Ply	Colour	Width (mm)	Length (m)	Pack Qty	Pallet Qty	Weight (kg)
003801	Fanfold	50	1	Brown	381	500	1	48	10
003800	Fanfold	50	1	Brown	762	500	1	24	20

Environmental impact rating See page 5



recycle



recyclability category  
FAP



75% minimum recycled content

### FillPak® Fanfold Paper - Virgin Kraft

Product Code	Type	GSM	Ply	Colour	Width (mm)	Length (m)	Pack Qty	Pallet Qty	Weight (kg)
008999	Fanfold	70	1	Brown	381	360	1	48	10
220977	Fanfold	60	1	White	381	500	1	48	48

Environmental impact rating See page 5



recycle



recyclability category  
FAP



0% recycled content

## Ranpak® PadPak® LC

### Fast, economic system to protect fragile products

The PadPak® LC paper cushioning system combines high speed with minimal paper usage, converting 1.2m of paper per second into a light, effective cushioning pad for efficient cushioning and wrapping. The LC can be operated by foot pedal or an operating panel. Height adjustable and tilt-able, it allows the operator to adapt the converter to the workplace.



## Ranpak® PadPak® LC+

The PadPak® LC PLUS is developed for medium/low cushioning segment. The possibility to run virgin as well as recycled paper that create big volume pads, makes this converter very versatile. You can use the converter to protect fragile and less fragile items that are 15 kg or less. Eco-line 70 and 90gsm recycled paper available.



## Ranpak® PadPak® CC

### Compact Cushioning

The PadPak® CC dispenses cushioning pads only 11cm wide, allowing them to snugly fit around smaller contents. This means a smaller box can be used and, as a result, less packing material is required.

The compact pads are easy to handle and can be used for a wide range of applications. They are produced on-demand with no bin filling required.



## Ranpak PadPak® JR

High quality paper cushioning for users requiring flexibility

Protective paper cushioning on demand, ideal for lower volume packing in distribution centres, mailrooms, retail outlets and for home office use.

The PadPak® Junior is compact, portable and easy to use, producing 0.3m of paper per second, through an electric feed with manual cutting. Table top and pedestal options also available. Weight 40kg.



## Ranpak PadPak® SR

The most versatile cushioning solution to protect heavy or fragile products

Ideal for high volume and labour-intensive packaging operations, the PadPak® Senior is supplied as either a stand-alone unit, integrated into a packing station operation, or built into a production line.

This flexible, height-adjustable micro-processor-controlled unit can convert 2 or 3-ply paper into cushioning pads on-demand, or pre-produced into a bin, at 0.42m per second.

With a range of user modes and automatic cutting, the Senior can also be pre-programmed to produce pads of differing lengths for packing complex products. The handy remote control clearly outlines all machine functions.

Optionally combined with Coiler and/or gluing plate. Weight 180kg.



## PadPak® Paper

For use with PadPak® LC, LC+, CC, JR & SR

Product Code	Suited For	Type	GSM	Ply	Colour	Width (mm)	Length (m)	Pack Qty	Pallet Qty	Weight (kg)
008956	PadPak® LC & LC+	Fanfold	70	1	Brown	762	360	1	24	20
008990	PadPak® LC & LC+	Fanfold	90	1	Brown	762	300	1	24	20
007975	PadPak® CC	Pack	70	1	Brown	381	360	1	48	10
007976	PadPak® CC	Roll	50/50	2	Brown	381	225	1	40	9
007977	PadPak® CC	Roll	50/70	2	Brown	381	180	1	40	8
003794	PadPak® JR	Roll	70/70	2	Brown	680	160	1	20	15
100401	PadPak® SR	Roll	50/50	2	Brown	762	400	1	11	30
005967	PadPak® SR	Roll	50/70	2	Brown	762	335	1	11	31
004054	PadPak® SR	Roll	70/70	2	Brown	762	290	1	11	32
006335	PadPak® SR	Roll	70/70	2	Brown	762	400	1	7	43
216082	PadPak® SR	Roll	50/50/50	3	Brown	762	145	1	20	29
220978	PadPak® SR	Roll	70/75	2	Brown	762	250	1	11	32
220457	PadPak® SR	Roll	70/70	2	White	762	290	1	11	32

Environmental impact rating See page 5



## Ranpak® WrapPak®

The innovative waved paper pads have been designed to offer one solution for multiple packaging applications, including box lining, wrapping, thermal insulation and block and bracing.

This helps minimise the amount of different packing materials needed to pack products, improving sustainability and simplifying packaging processes.

The pads are renewable and 100% recyclable and offer an enhanced product protection in transit due to their great shock absorption properties.



Product Code	Type	GSM	Ply	Colour	Width (mm)	Length (m)	Pack Qty	Pallet Qty	Weight (kg)
304369	Fanfold	60	2	Brown	380	450	1	48	10
292889	Fanfold	70	2	Brown	380	360	1	48	10

Environmental impact rating See page 5



recycle



recyclability category FAP



0% recycled content



Protective

## Ranpak® WrapPak® Protector

The WrapPak® Protector creates waved paper pads to solve challenges across many different packaging environments and applications. When box lining, its wide paper pads can cover an entire box surface with just one insert. Wrapping, blocking-and-bracing, interleaving, and even thermal insulation are also easily achieved. It means WrapPak® Protector can replace a wide range of existing packaging materials – so you don't have to keep ordering and monitoring stocks of boxes, aluminium-coated plastics, tapes, and inserts. The WrapPak® Protector (PT) converter is also highly programmable to match evolving needs, and is small enough to use at a pack table, in-line or as a standalone unit.



Local service with national coverage

Wide product range

Next day delivery available

Stock holding and call-off service





## Loosefill Packing Chips

These Loosefill Packing Chips are ideal for filling voids once items have been packed into their outer shipping cartons.

- Produced without CFC
- Cost effective: extremely high yield, unlimited storage life and low density for reduced transportation costs.
- Ideal for fragile and irregular shaped items
- 100% recycled content



Product Code	Volume (Cubic Feet)	Pack Qty
003178	15	1

Environmental impact rating See page 5



don't recycle



recyclability category PS



100% recycled content



## Pelaspán® Bio Loosefill

Pelaspán® Bio is an exceptionally eco-friendly, pourable loose fill padding material.

- 100% compostable
- Manufactured from cornstarch
- Fast packaging guaranteed
- S-Shape for optimal interlocking and secure cushioning
- Light weight and free flowing
- Dust free, anti-static, wear-resistant and odorless
- Cost effective
- Can be used without prior training



Product Code	Volume (Cubic Feet)	Pack Qty
003104	15	1

Environmental impact rating See page 5



don't recycle



NA



0% recycled content





## Loosefill Dispenser

### An essential tool in voidfill packing

Improve your packing operation by using a hopper kit that can deliver loosefill straight into the box. Can be used in conjunction with existing supports in your warehouse or used with a mobile frame.

Available in two sizes, the hopper kit includes scissor dispensing valve, trunking, pulleys, clips & cord.

Product Code	Description
007910	To fit 4 bags (60 cubic feet)
107008	Mobile Frame



## Mesh Sleeving

### A stretchy solution for awkward objects

Tubular, plastic stretch netting provides excellent protection against surface damage, scratches, scuffs and indentation in transit.

Particularly suitable for objects where surface protection is vital for example metal, glass, ceramic objects or items with a painted surface. This cost-effective packing solution is used by leading manufacturers and retailers to package and safeguard cylindrical and awkward-shaped items.

Available in a range of colours, weights and stretch capability, the sleeving is easily cut to the required length using scissors.

Plastic mesh netting is clean, dust free and environmentally friendly.

Mesh sleeving requires minimal storage space.

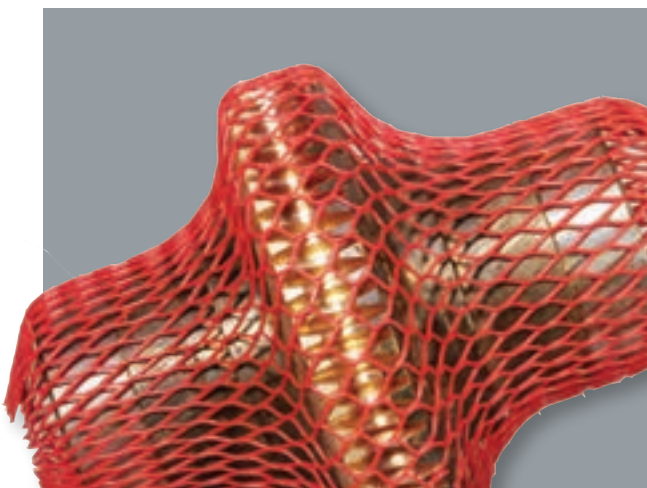

### Medium Weight\*

Product Code	Colour	To Fit Diameters (mm)	Length (m)	Pack Qty
004780	Orange	6-17	250	1 Reel
004781	Black	10-25	250	1 Reel
004782	Violet	18-65	50	1 Reel
004783	Red	50-100	50	1 Reel
004784	Yellow	100-200	50	1 Reel
004785	Blue	200-400	50	1 Reel

### Heavy Weight\*\*

Product Code	Colour	To Fit Diameters (mm)	Length (m)	Pack Qty
000069	Red	6-13	50	1 Reel
000070	Black	13-26	50	1 Reel
000071	Orange	26-40	25	1 Reel
000072	Brown	40-50	25	1 Reel
000073	White	50-65	25	1 Reel
000085	Straw	160-190	25	1 Reel
000074	Grey	65-80	25	1 Reel
000075	Yellow	80-100	25	1 Reel
000076	Blue	100-125	25	1 Reel
000078	Green	125-160	25	1 Reel
000087	Royal Blue	190-225	25	1 Reel

### High Stretch\*\*

Product Code	Colour	To Fit Diameters (mm)	Length (m)	Pack Qty
000605	Pink	20-45	50	1 Reel
000611	Purple	40-80	50	1 Reel
000618	Green	75-125	25	1 Reel

### Environmental impact rating See page 5

\*Medium Weight \*\*Heavy Weight and High Stretch



don't  
recycle



recyclability  
category  
LDPE



0%  
recycled\*\*  
content



30%  
minimum  
recycled  
content

Local service with  
national coverage

Wide product range

Next day delivery  
available

Stock holding and  
call-off service

## Edge Protectors

Cardboard edge protector strips help to reinforce cartons and cases, particularly aiding the protection of loads under stretch film or strapping and on pallets.

Product Code	Size (mm)	Length (mm)	Pack Qty
001564	35 x 35 x 3	1000	40
002082	35 x 35 x 3	1500	40
002083	60 x 60 x 4	1100	30



Environmental impact rating See page 5



recycle



recyclability category P4P



75% minimum recycled content

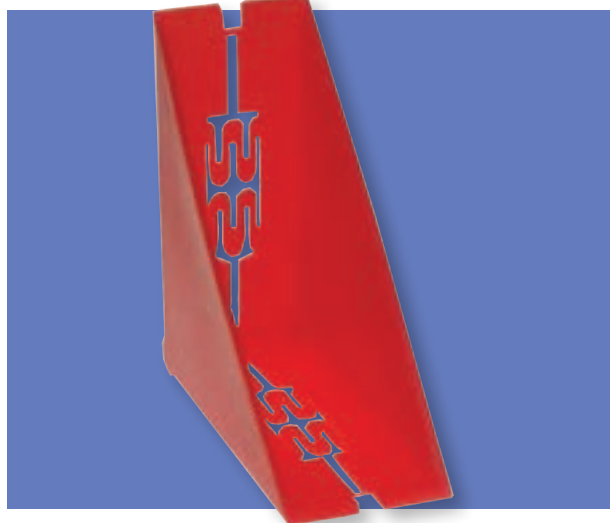

## Plastic Corner Protectors

Extra protection for vulnerable spots

These bright plastic corner covers protect the vulnerable spots on packaged items. The expandable middle section makes them suitable for many different items, including picture frames and paintings.

Product Code	Recyclability Category	Expanding Sizes (mm)	Pack Qty
007385*	5	4 - 7	5000
000013	4	14 - 40	1000
000014	4	40 - 70	250

Environmental impact rating See page 5



don't recycle



recyclability category 4&5



0% recycled content



## Foam Corner Protectors

Nomafoam®

Lightweight, simple and easy to use, these bright foam corner protectors are especially useful for fragile items, slipping neatly onto the corners of mirrors, photograph and picture frames.



Product Code	External Leg (mm)	Size Suitable for Edges Between	Pack Qty
001594	100 x 100	15-25 mm	600
001595	100 x 100	25-35 mm	450
002586	100 x 100	35-45 mm	300
002599	100 x 100	45-60 mm	500
002611	100 x 100	60-80 mm	400
002633	100 x 100	80-100 mm	280

Environmental impact rating See page 5



don't recycle



recyclability category OTHER



30% less than recycled content



## Foam Edge Protectors

Designed to absorb impact

Foam edge protection strips are recommended for protecting the corners and edges of furniture, equipment and machinery in transit.

Highly effective in absorbing shock impacts from knocks and bumps, Nomapack® strips are made from polyethylene foam and are available in U, L and O shaped profiles uniquely designed to fit snugly into place.

Supplied in 2m lengths and can be cut to size subject to MOQ.

### U Shape

Product Code	Wall Thickness (mm)	Colour	Size Suitable for Edges Between	Strip	Lengths Per Qty
001435	7	Blue	5 - 15 mm	2 Metres	280
001436	8	Blue	15 - 25 mm	2 Metres	160
001437	10	Blue	25 - 35 mm	2 Metres	120
001438	12	Blue	35 - 45 mm	2 Metres	90
001439	14	Blue	45 - 60 mm	2 Metres	50
001440	15	Blue	60 - 80 mm	2 Metres	40
221324	18	Blue	80 - 100 mm	2 Metres	36

### L Shape

Product Code	Wall Thickness (mm)	Colour	Size (mm x mm)	Strip	Lengths Per Qty
001441	6	Blue	50 x 50 mm	2 Metres	240
001442	10	Blue	75 x 75 mm	2 Metres	105

### O Shape

Product Code	Wall Thickness (mm)	Colour	Size (mm x m)	Strip	Lengths Per Qty
001443	9	Grey	15 x 1	1 Metre	190
001446	9	Grey	22 x 1	1 Metre	125
001447	9	Grey	28 x 1	1 Metre	95

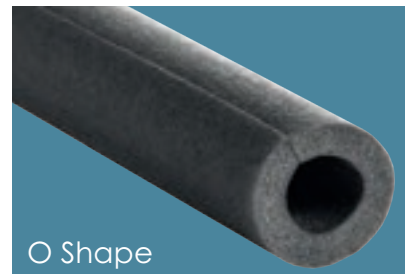
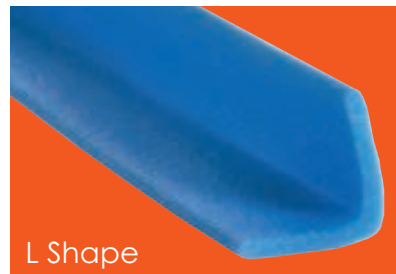
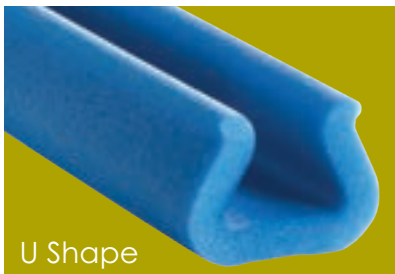

Environmental impact rating See page 5

don't recycle | 
 recyclability category OTHER | 
 30% less than recycled content



## ScreenGuard Foam Protection

Defence against wear and tear

Tubular foam protection provides impact-proof, padded resistance. Supplied on a roll.

\*Suitable for glass 3-6mm thick

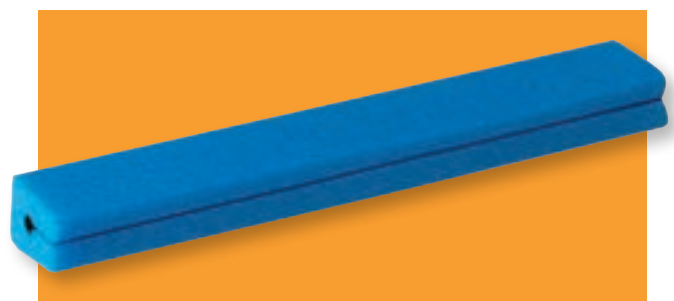

Product Code	Wall Thickness (mm)	Colour	Suitable for Glass up to 3mm Thick	Metres Per Roll
001449	3	Brown	32/20 x 3	590
001450	3	Blue	33/26 x 3 *	460

Environmental impact rating See page 5

don't recycle | 
 recyclability category OTHER | 
 30% less than recycled content

Local service with national coverage

Wide product range

Next day delivery available

Stock holding and call-off service

## Woodwool and Vermiculite

Versatile protectors with strong staying power



### Woodwool

Versatile woodwool can be used either as void fill or made into cushioned pads for the safe protection of bulky or fragile cargo.

Woodwool can be used to pad out boxes of fruit and vegetables, as well as decoratively in food hampers and toiletries. It is also a traditional stuffing for soft toys and taxidermy.

Product Code	Type	Grade	Weight	Pack Qty
000053	Wood Wool GTE 1	Medium	20kg	1
000051	Wood Wool GTE 2	Fine	20kg	1

Environmental impact rating See page 5



don't recycle



recyclability category 50 FOR



0% recycled content



### Vermiculite

Vermiculite provides fireproof, lightweight void fill, which can easily be placed around irregular objects. Its high absorbency makes it an ideal packaging solution for liquid items and is UN approved for use in transporting hazardous materials.

When heated Vermiculite expands up to 30 times its original volume, converting into a granular material. It stands the full shock of impact, retaining full absorbency and protection.

Fibre-free and containing no irritants, Vermiculite does not require protective clothing in handling.

Product Code	Type	Grade	Weight	Pack Qty
006890	Vermiculite	Lightweight	3.5 cu ft Bag	1

Environmental impact rating See page 5



don't recycle



NA



0% recycled content





# Paper

## Products

Corrugated Paper	80
Paper Bubble Wrap	80
Kraft Papers	81
Waxed Kraft Paper	82
Anti-Corrosion Kraft paper	83
Hand Rolls	83
Paper Packing Sheets	84
Copier Paper	84
Tissue Paper	85



Paper



Local service with national coverage

Wide product range

Next day delivery available

Stock holding and call-off service



# Paper

## Corrugated Single Faced Paper

A lightweight but strong and environmentally friendly packaging material, corrugated paper is ideal for wrapping or packing between boxed products.

It can be layered or scrunched, providing excellent protection and cushioning. Our single wall papers are made from 90 gsm waste based testliner with a 'C' Flute.

Corrugated rolls are made from recycled fibres and are easily recyclable.



Product Code	Size (mm x m)	Pack Qty
001372	150 x 75	1
003151	175 x 75	1
001303	225 x 75	1
003072	250 x 75	1
001304	275 x 75	1
000291	300 x 75	1
000632	350 x 75	1
001375	450 x 75	1
000251	500 x 75	1
000301	600 x 75	1
000287	650 x 75	1
000293	750 x 75	1
000289	900 x 75	1
100217	1000 x 75	1
000743	1050 x 75	1
000290	1200 x 75	1
001290	1350 x 75	1
001291	1500 x 75	1
110171	1600 x 75	1
000019	1800 x 75	1
003085	1950 x 75	1
000294	2000 x 75	1
151951	2100 x 75	1
109384	2150 x 75	1

Environmental impact rating See page 5



recycle



recyclability category  
PAP



minimum recycled content

## Paper Bubble Wrap

This cutting-edge globular embossed product is made of recycled paper and is fully recyclable, which makes it a perfect, environmentally-friendly alternative to traditional bubble wrap.

Deep indentions in the paper provide excellent shock absorbing properties, ensuring reliable product protection in transit.

Paper bubble wrap is available in various sizes and can be used to wrap around items as well as to fill gaps inside packages for enhanced cushioning of delicate and / or expensive products.

Custom sizes available  
Call Us

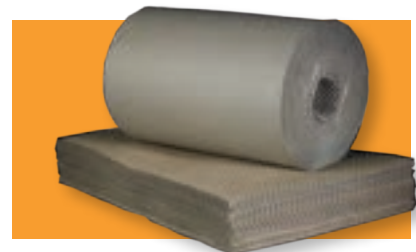

Product Code	Size (mm x m)
474623	650 x 75
116181	650 x 150
108927	750 x 75
267879	900 x 75
288277	305 x 100

Environmental impact rating See page 5



recycle



recyclability category  
PAP



minimum recycled content

## Kraft Ribbed Paper

### High performance wrapping

Pure kraft paper is a strong, high performance wrapping paper, manufactured from sustainable sources. This makes it ideal for medium and heavy-duty packing tasks where high burst strength is required for lining or wrapping box contents.

Available in a variety of sheet and roll sizes, in 70 or 88 gsm.



### Rolls

Product Code	Size (mm x m)	Paper Weight (gsm)	Approx Weight (kg)	Pack Qty
000197	500 x 280	70	9.90	1
001955	500 x 220	88	9.90	1
000130	600 x 280	70	11.76	1
000217	600 x 220	88	11.76	1
000132	750 x 280	70	14.85	1
000133	750 x 220	88	14.85	1
000134	900 x 280	70	17.64	1
000135	900 x 220	88	17.64	1
000145	1150 x 280	70	22.54	1
001954	1150 x 220	88	22.54	1
002048	1500 x 220	88	29.70	1

### Sheets

Product Code	Size (mm x mm)	Paper Weight (gsm)	Approx Weight (kg)	Pack Qty
000136	700 x 1150	70	14.00	240
000137	700 x 1150	88	18.11	240
000138	900 x 1150	70	18.11	240
000139	900 x 1150	88	23.00	240
000141	1150 x 1400	88	18.11	120



Paper

Environmental impact rating See page 5



recycle

recyclability  
category  
PAP0% recycled  
content

## Filla Paper Roll

### An economy choice for voidfill packing

This economy paper is ideal for scrunching up as voidfill for a wide range of packaging.

It can be recycled with other paper products and offers minimal waste, as you can cut what is required from the roll.

Wall mountable paper dispensers are available for quick & easy use.

Product Code	Size (mm x m)	Roll Weight (kg)	Pack Qty
000228	600 x 450	14.85	1
001582	900 x 450	22.75	1



Environmental impact rating See page 5



recycle

recyclability  
category  
PAP50% minimum  
recycled  
content

Local service with  
national coverage

Wide product range

Next day delivery  
available

Stock holding and  
call-off service

## Ribbed Imitation Kraft Paper

A cost-effective choice for general wrapping

Imitation kraft paper has a ribbed finish.

Suitable for light to medium duty wrapping tasks, it provides a cost-effective alternative to pure kraft paper.



### Rolls

Product Code	Size (mm x m)	Paper Weight (gsm)	Approx Weight (kg)	Pack Qty
001762	450 x 200	88	7.92	1
005209	500 x 200	88	9.00	1
001213	600 x 200	88	10.80	1
001216	750 x 200	88	13.50	1
001218	900 x 200	88	16.20	1
001763	1150 x 200	88	20.70	1

### Sheets

Product Code	Size (mm x mm)	Paper Weight (gsm)	Approx Weight (kg)	Pack Qty
000238	700 x 1150	88	18.11	240
000239	900 x 1150	88	22.35	240
003213	1150 x 1400	88	17.38	120

Environmental impact rating See page 5



recycle



recyclability category PAF



50% minimum recycled content



## Waxed Kraft Paper Roll

A waterproof shield against moisture damage

High quality kraft paper rolls with a shiny wax coating create a moisture-proof barrier, adding water-repellent protection for the products wrapped inside.

Product Code	Size (mm x m)	Paper Weight (gsm)	Approx. Weight (kg)	Pack Qty
004252	600 x 100	55	6.60	2
002982	900 x 100	55	9.90	2

Environmental impact rating See page 5



don't recycle



recyclability category PAF



0% recycled content

Polythene solution also available  
Call Us

Custom sizes and printing available  
Call Us

## Anti-Corrosion Kraft Rustop Paper Roll (VCI Kraft)

No-rust wrapping solution for ferrous metals

This premium quality kraft paper is coated with a Volatile Corrosion Inhibitor (VCI), which is highly effective in protecting ferrous metal products from rusting during transportation and storage.

Product Code	Size (mm x m)	Paper Weight (gsm)	Approx. Roll Weight (kg)	Pack Qty
001265	1000 x 200	55	11.00	1



Environmental impact rating See page 5



don't recycle



recyclability category P22



0% recycled content



Paper

## Centre Feed Hand Rolls

Designed for office, kitchen, restroom, workshop and warehouse environments. These 2-ply white centre feed rolls contain no core. Instead they are fixed within a dispenser with the towel pulled through. 150m long. Six rolls per pack.

Product Code	Product Description	Size (mm x m)	Pack Qty
001294	2 Ply - Blue	190 x 150	6
001295	2 Ply - White	190 x 150	6



Environmental impact rating See page 5



recycle



recyclability category P22



0% recycled content

Local service with national coverage

Wide product range

Next day delivery available

Stock holding and call-off service

## Paper packing sheets

### Newsprint off-cuts

This multi-use packing paper originates from newsprint offcuts and has a soft feel with a slight sheen. It is a cost-effective choice for house moving or storage, providing safe packing for crockery, glass and other home wares.

Recyclable with other paper-based products, the paper is also ideal for scrunching up as voidfill.

Product Code	Size (mm x mm)	Approx. Pack Qty	Approx. Weight (kg)
000044	500 x 750	300	5
196672	500 x 750	560	10
000267	500 x 750	700	12.5
007741	750 x 1000	287	10

Newsprint offcut paper is ideal for wrapping fragile items



Large sheets provide cost effective recyclable packing

Environmental impact rating See page 5



recycle



recyclability category P4P



0% recycled content

FSC available

75gsm available

Coloured paper available

## Copier paper

### Multi-purpose A4 reams

Macfarlane A4 copier paper is an excellent general choice for printing, copying and writing tasks.

This 80gsm multi-purpose paper is suitable for laser and ink-jet printers, photocopiers, fax machines and all-in-one multi-functional printers.

Product Code	Size (mm x mm)	Paper weight (gsm)	Pack Qty
219940	210 x 297 (A4)	80	5 reams



Environmental impact rating See page 5



recycle



recyclability category P4P



50% minimum recycled content



# Tissue Paper

Coloured  
paper  
available

Custom  
sizes and  
printing  
available  
Call Us

Macfarlane tissue paper comes in a spectrum of shades and finishes.

**Acid-free tissue paper** is suitable for jewellery and silverware, as the items will not tarnish when wrapped.

**Non-toxic tissue paper** is suitable for use with food produce, since there are no toxins to pass on to the food.

**Bleed-resistant tissue paper** is the perfect choice for garment wrapping, as the paper will not run off or stain if it comes into contact with moisture.

**Machine glazed (MG) tissue paper** has a shiny appearance on one side, remaining matt on the reverse to provide contrast in wrapping. Not suitable for use with jewellery, silverware or fabrics unless acid free.

**Machine finished (MF) tissue paper** has a matt finish on both sides.



Product Code	Colour	Finish	Size (mm)	GSM	Acid Free	Non Toxic	Bleed Resistant	Pack Qty (Sheets)
248410	Red	MF	500 x 750	18	•	•	•	480
248480	Black	MF	500 x 750	18	•	•	•	480
248896	Sky Blue	MF	500 x 750	18	•	•	•	480
249206	Peach	MF	500 x 750	18	•	•	•	480
249207	Plum	MF	500 x 750	18	•	•	•	480
249210	Periwinkle	MF	500 x 750	18	•	•	•	480
249214	Lilac	MF	500 x 750	18	•	•	•	480
249216	Burgundy	MF	500 x 750	18	•	•	•	480
249351	Cerise	MF	500 x 750	18	•	•	•	480
249352	Chocolate	MF	500 x 750	18	•	•	•	480
249357	Groovy Green	MF	500 x 750	18	•	•	•	480
249358	Forest Green	MF	500 x 750	18	•	•	•	480
249359	Dune Beige	MF	500 x 750	18	•	•	•	480
249367	Turquoise	MF	500 x 750	18	•	•	•	480
249368	Dark Blue	MF	500 x 750	18	•	•	•	480
249369	Dandelion	MF	500 x 750	18	•	•	•	480
249371	Orange	MF	500 x 750	18	•	•	•	480
249373	Light Pink	MF	500 x 750	18	•	•	•	480
249375	Pink	MF	500 x 750	18	•	•	•	480
249376	Hot Pink	MF	500 x 750	18	•	•	•	480
249377	Silver	MF	500 x 750	18	•	•	•	200
249378	Gold	MF	500 x 750	18	•	•	•	200
249379	Bronze	MF	500 x 750	18	•	•	•	200
002748	White	MF	450 x 700	17	•	•	•	480
005110	White	MF	500 x 750	17	•	•	•	480
000240	White	MG	375 x 500	18	•	•	•	480
003172	White	MG	400 x 600	18	•	•	•	480
000259	White	MG	450 x 700	16	•	•	•	480
000244	White	MG	450 x 700	19	•	•	•	480
000245	White	MG	500 x 750	19	•	•	•	480
000165	White	MG	500 x 750	16	•	•	•	480



Paper

Environmental impact rating See page 5



recycle



recyclability  
category  
PAP



0%  
recycled  
content

Local service with  
national coverage

Wide product range

Next day delivery  
available

Stock holding and  
call-off service

# The Packaging Optimiser protects your profit and the environment



The Packaging Optimiser from Macfarlane Packaging can help you protect margins and the environment by eliminating the hidden costs in your packaging operation.



Find out what your packaging operation is really costing your business and the planet

[macfarlanepackaging.com/optimiser](https://macfarlanepackaging.com/optimiser)

## What will you protect?



# Tapes

## Selecting The Right Tape 88

### Products

Polypropylene Tapes	89
PVC Vinyl Tapes	91
Eco Tapes	91
Masking Tapes	92
Paper Tapes	92
Gummed Paper Tapes	93
Gummed Paper Tape Dispensers	93
Coloured Tapes	94
Printed Warning Tapes	95
Filament Tapes	96
Tamper Evident Tapes	96
Machine Applied Tapes	97
Double Sided Tapes	97
Cloth Tapes	97
Floor Marking Tapes	98
Tape Dispenser	98



Tapes



Local service with national coverage

Wide product range

Next day delivery available

Stock holding and call-off service

# Selecting The Right Tape

## Vinyl (PVC)

Description	Best For/Most Suitable Application	Adhesive Types
<ul style="list-style-type: none"> <li>• Matt Finish</li> <li>• Quiet coming off the roll</li> <li>• Slow release</li> <li>• Does not stretch</li> <li>• Can be torn by hand</li> </ul>	<ul style="list-style-type: none"> <li>• Long term storage</li> <li>• Easy to apply with dispenser</li> <li>• Best used at 18-21°C</li> </ul>	<ul style="list-style-type: none"> <li>• Solvent – best long-term adhesive</li> </ul>

## Polypropylene

Description	Best For/Most Suitable Application	Adhesive Types
<ul style="list-style-type: none"> <li>• Shiny Finish</li> <li>• Difficult to tear, requires dispenser or knife to cut</li> <li>• Noisy coming off the roll</li> <li>• Quick release</li> <li>• Does stretch</li> </ul>	<ul style="list-style-type: none"> <li>• Economical</li> <li>• High initial grab</li> <li>• Performs well in deep-freeze conditions</li> </ul>	<ul style="list-style-type: none"> <li>• Solvent - best long-term adhesive</li> <li>• Hot Melt - solvent free adhesive</li> <li>• Acrylic - water-based adhesive (environmentally friendly)</li> </ul>

## Low Noise Polypropylene

Description	Best For/Most Suitable Application	Adhesive Types
<ul style="list-style-type: none"> <li>• Shiny Finish</li> <li>• Slow release</li> </ul>	<ul style="list-style-type: none"> <li>• Combines to strength of polypropylene with the noiseless aspect of vinyl</li> </ul>	<ul style="list-style-type: none"> <li>• Solvent - best long-term adhesive</li> <li>• Acrylic - water-based adhesive (environmentally friendly)</li> </ul>



# Tapes

## Value Tapes – Polypropylene

The cost-effective option

Our value tapes are made using 25-micron BOPP polypropylene film with a water-based, acrylic adhesive.

For exceptional performance with reduced noise, choose our low noise polypropylene tapes. These combine strength with speed and are quiet off the roll.

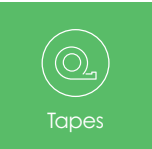

### Standard Tapes

Product Code	Colour	Size (mm x m)	Tape Microns	Core Size (mm)	Pack Qty
000877	Clear	48 x 66	25	75	36
000650	Buff	48 x 66	25	75	36

### Low Noise Tapes

Product Code	Colour	Size (mm x m)	Tape Microns	Core Size (mm)	Pack Qty
003671	Clear	48 x 66	28	75	36
003670	Buff	48 x 66	28	75	36

Environmental impact rating See page 5



don't forget...

SEE PAGE 98  
Tape dispenser

SEE PAGE 12  
Single wall boxes

SEE PAGE 132  
Packing opener

SEE PAGE 74  
Loosefill

Local service with national coverage

Wide product range

Next day delivery available

Stock holding and call-off service



## Standard Tapes – Polypropylene

High performance with durable adhesion

Macfarlane's strong standard polypropylene tapes are renowned for their high performance, with on-going adhesion.

Manufactured using 25-micron BOPP polypropylene, in buff or clear shiny-finish, standard tapes come either with solvent-based adhesives, for long-term sealing, or hot melt adhesives, recognised for their versatile application, superior tensile strength and ultimate fixing power.

These standard tapes are hard to tear and therefore require a hand dispenser for cutting.

For top performance with a quieter release, choose low noise polypropylene packing tapes.



Buff

Clear

### Hot Melt

Product Code	Colour	Size (mm x m)	Tape Microns	Core Size (mm)	Pack Qty
000386	Buff	25 x 66	25	75	72
000153	Clear	25 x 66	25	75	72
002648	Buff	48 x 66	25	75	36
009003	Clear	48 x 66	25	75	36
009006	Buff	48 x 132	25	75	36
002645	Clear	48 x 132	25	75	36
000241	Buff	72 x 66	25	75	24
000243	Clear	72 x 66	25	75	24

### Low Noise Solvent

Product Code	Colour	Size (mm x m)	Tape Microns	Core Size (mm)	Pack Qty
009109	Buff	48 x 66	30	75	36
009023	Clear	48x 66	30	75	36

### Solvent

Product Code	Colour	Size (mm x m)	Tape Microns	Core Size (mm)	Pack Qty
009012	Clear	12 x 66	25	75	144
009013	Clear	19 x 66	25	75	96
009014	Clear	25 x 66	25	75	72
009019	Buff	48 x 66	25	75	36
009017	Clear	48x 66	25	75	36
009020	Buff	48x 132	25	75	36
009018	Clear	48x 132	25	75	36
009022	Buff	75x 66	25	75	24
009120	Clear	75x 66	25	75	24

Environmental impact rating See page 5



don't recycle



recyclability category PP



0% recycled content

## Premium Tapes

### PVC Vinyl

Our premium packing tapes are manufactured using 32-micron vinyl and solvent-based adhesive for long-term sealing.



Product Code	Colour	Duty	Size (mm x m)	Tape Microns	Core Size (mm)	Pack Qty
000711	Clear	Standard	12 x 66	32	75	144
000714	Clear	Standard	19 x 66	32	75	96
000715	Clear	Standard	25 x 66	32	75	72
000803	Buff	Standard	25 x 66	32	75	72
009024	Clear	Standard	48 x 66	32	75	36
009026	White	Standard	48 x 66	32	75	36
009025	Buff	Standard	48 x 66	32	75	36
000405	Buff	Standard	48 x 132	32	75	36
000719	Clear	Standard	75 x 66	32	75	24
000801	Buff	Standard	75 x 66	32	75	24
000896	Buff	Heavy	48 x 66	60	75	36
000889	Buff	Heavy	75 x 66	60	75	24

Environmental impact rating See page 5



don't  
recycle



recyclability  
category  
PVC



0%  
recycled  
content



Tapes

## Eco Tape

200m acrylic polypropylene tape on a 50mm core.  
Made from 25mu polypropylene film, but with a stronger, more effective adhesive – 20gsm.

Over 3 times as much tape on a roll, meaning:

- 3 x FEWER cartons shipped to a customer
- 3 x FEWER cartons stored in customer warehouse
- 3 x FEWER rolls changed

Product Code	Colour	Microns	Size (mm x m)	Core Size (mm)	Pack Qty
222267	Clear	25	48 x 200	50	36
222275	Brown	25	48 x 200	50	36



Environmental impact rating See page 5



don't  
recycle



recyclability  
category  
PP



0%  
recycled  
content

Local service with  
national coverage

Wide product range

Next day delivery  
available

Stock holding and  
call-off service

## PET Tape

Polyester adhesive tape with a minimum 70% recycled plastic material. The reduced thickness allows for increased meterage per roll. Good adhesion at high or low temperatures. Works with standard or recycled boxes.

High mechanical tear resistance.

Product Code	Colour	Type	Size (mm x m)	Tape Microns	Core Size (mm)	Pack Qty
1001057	Buff	Noisy	48 x 100	19	75	Add
1001056	Clear	Noisy	48 x 100	19	75	Add
1001058	Buff	Low Noise	48 x 100	23	75	Add
1001059	Clear	Low Noise	48 x 100	23	75	Add

Environmental impact rating See page 5



recycle



recyclability category  
PETE



60% minimum recycled content

## Paper Tapes

If you are looking for an alternative to plastic tape, we offer a range of recyclable and biodegradable paper tapes. Available in either a self-adhesive or gummed format, these tapes are an environmentally friendly substitute for carton sealing.

## Self Adhesive Paper Tape

Self-adhesive paper tape is a recyclable alternative to plastic based tapes. Using a Hot Melt adhesive and adhering directly to the box, it can be applied using a standard tape gun. We offer the tape in either a matt or gloss finish, to enhance the look of your shipments.

Our self-adhesive paper tape range is fully recyclable but, unlike gummed paper tape, this product does not biodegrade and is not home compostable due to the addition of Hot Melt adhesive. However, the tape can be recycled in the waste paper stream as the adhesive is removed during processing.



Product Code	Size (mm x m)	Core Size (mm)	Pack Qty
1001061	50 x 50	75	36
301998	48 x 75	50	36

Environmental impact rating See page 5



recycle



recyclability category  
FAP



0% recycled content

## Masking Tape

General purpose masking tape is easy to tear and removes cleanly after use. Macfarlane's range of masking tapes is manufactured from flexible creped paper and can be used in temperatures up to 60°C.

Product Code	Size (mm x m)	Core Size (mm)	Pack Qty
003155	12 x 50	75	72
001108	18 x 50	75	48
001099	24 x 50	75	36
001084	38 x 50	75	24
001062	48 x 50	75	24
001053	74 x 50	75	16



Environmental impact rating See page 5



recycle



recyclability category  
FAP



0% recycled content

## Gummed Paper Tapes

Biodegradable and recyclable gummed paper tapes from Macfarlane provide an environmentally friendly alternative for standard packaging. These hardwearing tapes are suitable for sealing all parcels and cartons.

Tapes require water to activate the adhesive. A paper tape dispenser is required to moisten, cut and dispense tape automatically. Once removed from the box the tape cannot be resealed and therefore provides visible evidence of any tampering. It is also tolerant of storage temperature fluctuations.

- Stronger than standard packaging tape
- Excellent tamper evident solution
- Tolerant to temperature fluctuations
- Smart presentation
- Increased productivity
- Cost effective

Product Code	Quality	Type	Size (mm x m)	Core Size (mm)	Pack Qty
005462	K70	Plain	48 x 200	75	30
005461	K60	Plain	70 x 200	75	20
005463	K70	Plain	70 x 200	75	18
106885	K130	Reinforced	48 x 100	75	24
002125	K130	Reinforced	72 x 100	75	16

Custom printing options available  
Call Us

A paper tape dispenser is required to moisten, cut and dispense tape automatically.

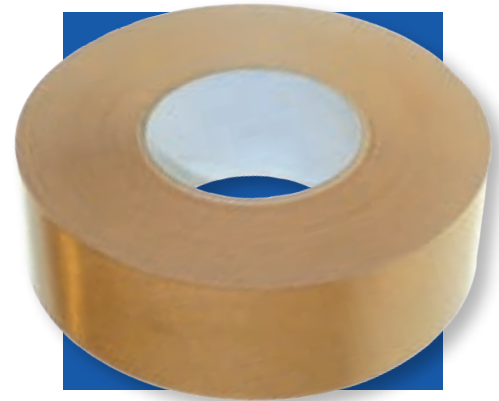

Environmental impact rating See page 5



recycle



recyclability category  
FAP



0% recycled content



## Manual Gummed Paper Tape Dispenser

Suitable for low shipment volumes, the BP222 manual gummed paper tape dispenser is a great solution where there is limited electrical power supply.

Product Code	Model	Pack Qty
310987	BP222	1

Tapes

## Electronic Gummed Paper Tape Dispenser

Perfect adhesion with automatic control.

Moistens, cuts and delivers pre-programmed lengths of gummed paper tape.

Product Code	Model	Pack Qty
162494	BP500	1
203867	BP555	1



Local service with national coverage

Wide product range

Next day delivery available

Stock holding and call-off service

## Coloured Tapes

Macfarlane's coloured packing tapes make it easy to identify bundled or packed items for shipping or storage.

Create a colour coded packing system using either polypropylene hot melt or PVC vinyl tapes in a choice of six shades.



### Polypropylene Hot Melt

Product Code	Colour	Size (mm x m)	Microns	Core Size (mm)	Pack Qty
009043	Yellow	48 x 66	25	75	36
009034	Blue	48 x 66	25	75	36
009036	Red	48 x 66	25	75	36
001965	Green	48 x 66	25	75	36
103384	White	48 x 66	25	75	36
105094	Black	48 x 66	25	75	36

Environmental impact rating See page 5



### PVC Vinyl

Product Code	Colour	Size (mm x m)	Microns	Core Size (mm)	Pack Qty
000851	Yellow	25 x 66	32	75	72
000507	Red	25 x 66	32	75	72
009026	White	48 x 66	32	75	36
000380	Black	48 x 66	32	75	36
000766	Yellow	48 x 66	32	75	36
000872	Red	48 x 66	32	75	36
000870	Blue	48 x 66	32	75	36
000871	Green	48 x 66	32	75	36

Environmental impact rating See page 5





## Printed Warning Tapes

A clear message for safe handling

These printed warning tapes provide dual-purpose protection for delicate or high value goods.

The clear message gives easily visible instructions on safe handling during transit and storage, while the tough adhesive tape ensures packages remain secure.

Printed tapes can also show where cartons have been opened or tampered with.

With a choice of seven messages, Macfarlane can also customise your individual warning message. Available in white printed PVC vinyl or low-noise polypropylene.



### Low Noise Polypropylene

Product Code	Descriptions	Adhesive	Size (mm x m)	Core Size (mm)	Pack Qty
009920	Caution	Acrylic	48 x 66	75	36
005319	Fragile	Acrylic	48 x 66	75	36
009919	Handle With Care	Acrylic	48 x 66	75	36
009921	Glass With Care	Acrylic	48 x 66	75	36
009922	QC Inspected	Acrylic	48 x 66	75	36

Environmental impact rating See page 5



don't  
recycle



recyclability  
category  
PP



0%  
recycled  
content



Tapes

### PVC Vinyl

Product Code	Descriptions	Adhesive	Size (mm x m)	Core Size (mm)	Pack Qty
000295	Caution	Solvent	48 x 66	75	36
000634	Fragile	Solvent	48 x 66	75	36
000709	Glass Handle With Care	Solvent	48 x 66	75	36
003637	Security	Solvent	48 x 66	75	36
000048	Handle With Care	Solvent	48 x 66	75	36

Environmental impact rating See page 5



don't  
recycle



recyclability  
category  
PVC



0%  
recycled  
content

Local service with  
national coverage

Wide product range

Next day delivery  
available

Stock holding and  
call-off service

## Reinforced Filament Tapes

Extra strength for heavyweight packaging

This extremely strong adhesive tape is reinforced with glass fibre filaments either down the length of the tape (single weave) or across and down the tape (cross weave). A popular solution for bundling bulky items and sealing or reinforcing heavy boxes, reinforced filament tape is also a widespread choice for packing in the steel industry as a replacement for steel and polypropylene strapping.

A packing knife or scissors is required to cut reinforced filament tape, offering tamper-evident qualities, as any cut will be easily noticed.



Product Code	Type	Size (mm x m)	Core Size (mm)	Pack Qty
003045	Single Weave Filament Tape	25 x 50	75	36
003046	Single Weave Filament Tape	50 x 50	75	18
000641	Cross Weave Filament Tape	19 x 50	75	48
000104	Cross Weave Filament Tape	24 x 50	75	72
000103	Cross Weave Filament Tape	48 x 50	75	36
000105	Cross Weave Filament Tape	74 x 50	75	24

Environmental impact rating See page 5



don't  
recycle



recyclability  
category  
PVC



0%  
recycled  
content



## Tamper Evident Tapes

Plain and simple security for precious parcels

Custom options available  
Call Us

This cost-effective security tape is a plain and simple deterrent, offering clear visibility when a parcel has been tampered with.

One of Macfarlane's best-selling products, it adds a seal of security to high value parcels, display packaging, cash bags and computer software.

If the tape has been removed or tampered with, a 'void opened' message appears on the package surface. Once pulled away the tape cannot be reused or resealed without being noticed.

Product Code	Colour	Size (mm x m)	Pack Qty
008404	Red	50 x 50	24

Environmental impact rating See page 5



don't  
recycle



recyclability  
category  
PVC



0%  
recycled  
content

## Machine Applied Tapes

Designed for use with automatic and semi-automatic tape machines, these specially manufactured packing tapes are suitable for use in the food industry.

The polypropylene construction and shiny finish provides quick release off the roll.

Product Code	Colour	Size (mm x m)	Tape Microns	Tape Adhesive	Core Size (mm)	Pack Qty
005766	Buff	48 x 990	28	Hot Melt	75	6
009035	Clear	48 x 990	28	Hot Melt	75	6
009039	Clear	48 x 990	28	Solvent	75	6

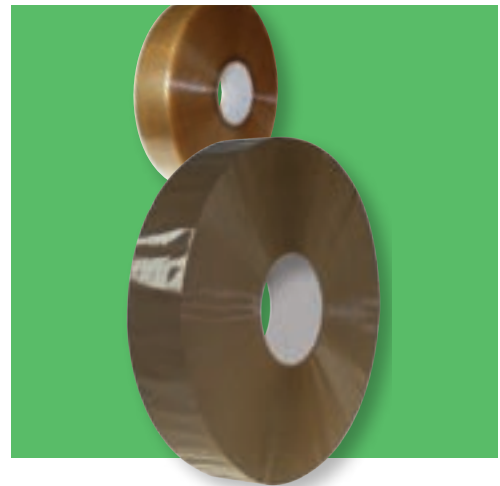

Environmental impact rating See page 5

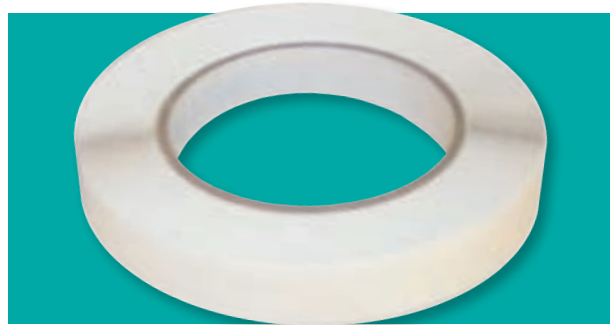

## Double Sided Tapes

Double-sided polypropylene tapes create firm tack, due to the hot melt glue used in the manufacture. A knife or scissors are recommended for cutting tape from the roll. Double-sided tissue tapes are coated on both sides with a clear adhesive.

Our range of double-sided fingerlift tapes is manufactured with a hot melt glue recognised for versatile application, superior tensile strength and strong adhesion.

Product Code	Type	Size (mm x m)	Core Size (mm)	Pack Qty
006908	Double Sided Polypropylene Tape	50 x 50	75	24
000835	Double Sided Tissue Tape	25 x 50	75	48
004996	Double Sided Fingerlift Tape	12 mm (backing) and 6 mm (tape) x 50 m	75	96
006909	Double Sided Fingerlift Tape	18mm (backing) and 12mm (tape) x 50 m	75	60

Environmental impact rating See page 5



## Cloth Tapes

Black cloth, or 'gaffa' or 'duct' tapes are a professional, multi-purpose solution for heavy-duty sticking tasks.

The cotton mesh construction and waterproof finish, with super-strong, rubber compound adhesive, provides a lasting bond for a broad range of requirements, including rolled-up carpets and rugs, securing cables, temporary flooring, flooring protection and averting tripping hazards.

Product Code	Tape Material	Size (mm x m)	Core Size (mm)	Pack Qty
219296	Cloth	50 x 50	75	24

Environmental impact rating See page 5



Local service with national coverage

Wide product range

Next day delivery available

Stock holding and call-off service

## Floor Marking Tapes

A cost-effective solution for designated areas

Select your colour from this range of six floor marking tapes manufactured for Macfarlane.

The general purpose vinyl adhesive tapes are visibly bright, extremely strong and provide a cost-effective option for factory and warehouse use, where designated areas need marking out for storage, walkways, truck routes, loading bays and any hazard spots.

Very long lasting and much easier and cleaner to apply than paints.



Product Code	Colour	Size (mm x m)	Core Size (mm)	Pack Qty
000325	Black/Yellow Marking Tape	50 x 33	75	24
000310	Green Marking Tape	50 x 33	75	24
000314	Grey Marking Tape	50 x 33	75	24
000320	Red Marking Tape	50 x 33	75	24
000321	White Marking Tape	50 x 33	75	24
000322	Yellow Marking Tape	50 x 33	75	24

Environmental impact rating See page 5

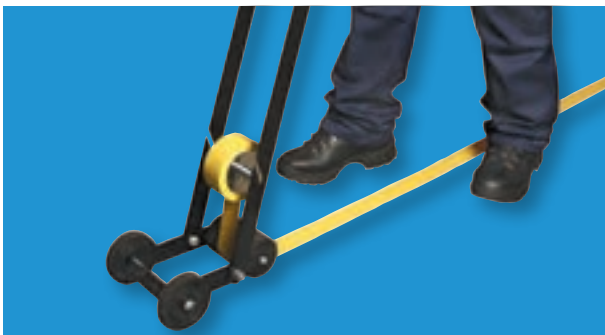

## Floor Marking Tape Applicator

A convenient way to mark out factory floors, sports halls, canteens, etc. Applicator is suitable for tapes up to 100 mm wide.

Product Code	Pack Qty
005481	1 Unit



## Hand-Held Tape Dispenser

Product Code	Core Size (mm)	Suitable for Widths (mm)	Pack Qty
000118	75	48	1
001374	75	75	1

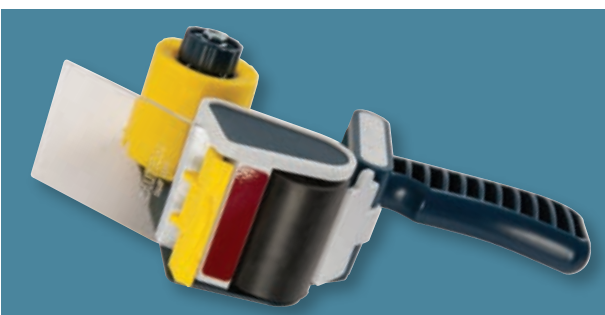

## Eco Tape Dispenser

For use with 50 mm core Eco Tape only.

Product Code	Core Size (mm)	Pack Qty
226567	50	1





# Polythene

## Products

Layflat Polythene Tubing	100
Heat Sealers	101
Protective Sheeting	102
Shrink Film	103
VCI Polythene page	104
Shrink Film Gun	105



Polythene



Local service with national coverage

Wide product range

Next day delivery available

Stock holding and call-off service



# Polythene

## Layflat Polythene Tubing

A versatile, budget packing solution

An amazingly simple, yet highly effective, budget packing solution with broad flexibility, in particular for protecting long length items such as piping, tubing and wooden mouldings.

Layflat polythene tubing can be used to make polythene bags to size by using a heat sealer.

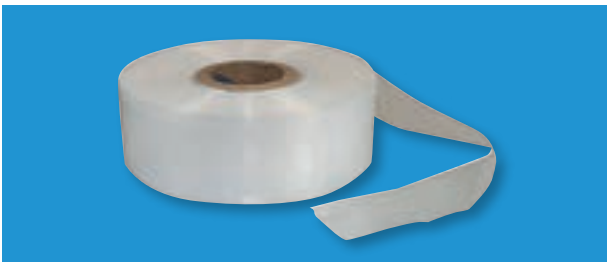

Custom printing available  
Call Us

### Medium Duty

Product Code	Width (mm)	Width (inches)	Length (m)	Approx. Net Weight (kg)	Pack Qty
004123	50	2	420	2	1 Roll
002401	75	3	420	3	1 Roll
002402	100	4	420	4	1 Roll
002418	125	5	420	5	1 Roll
002438	150	6	420	6	1 Roll
002441	175	7	420	7	1 Roll
002444	200	8	420	8	1 Roll
002454	225	9	420	9	1 Roll
002461	250	10	420	10	1 Roll
002465	300	12	420	12	1 Roll
002469	350	14	420	14	1 Roll
002491	400	16	420	16	1 Roll
002499	450	18	420	18	1 Roll
002510	500	20	420	20	1 Roll
002512	600	24	420	24	1 Roll
002534	900	36	210	18	1 Roll
252741	750	29	210	15	1 Roll

### Heavy Duty

Product Code	Width (mm)	Width (inches)	Length (m)	Approx. Net Weight (kg)	Pack Qty
004139	50	2	210	2	1 Roll
002546	75	3	210	3	1 Roll
002548	100	4	210	4	1 Roll
002550	125	5	210	5	1 Roll
002551	150	6	210	6	1 Roll
002564	175	7	210	7	1 Roll
002583	200	8	210	8	1 Roll
002597	225	9	210	9	1 Roll
002602	250	10	210	10	1 Roll
002618	300	12	210	12	1 Roll
002624	350	14	210	14	1 Roll
002625	400	16	210	16	1 Roll
002642	450	18	210	18	1 Roll
002670	500	20	210	20	1 Roll
002673	600	24	210	24	1 Roll
002704	900	36	105	18	1 Roll
252742	750	29	105	15	1 Roll

Environmental impact rating See page 5



recycle with bags at large supermarkets  
DON'T RECYCLE AT HOME



recyclability category  
LDPE



30% minimum recycled content

## Magneta Heat Sealers

The Sealmaster Magneta has a proven track record delivering failsafe, top quality performance.

In production for 25 years, this robust machine remains one of the world's most popular heat sealers. It can be operated by hand, or with the optional foot pedal and is equipped with a magnetic hold-down device, which ensures consistency, independently of the operator.

User-friendly and safe to handle, these machines are ideal for use with polythene, polypropylene, laminates and some foils. Using the inbuilt cutting device, they also work well with pre-made bags or layflat tubing material.

Product Code	Description	Seal Length (mm)
000347	Magneta 421mg Heat Sealer	420
001050	Magneta 620mm Heat Sealer	620
001026	Magneta 820mm Heat Sealer	820
001064	Magneta 1020mm Heat Sealer	1020



**3 year warranty**

\*Doesn't cover consumables

## Heat Sealer with Cutter

This impulse heat sealer is manufactured for polythene up to 400 mm wide and has a 12-month warranty covering non-consumable parts and labour.

The sealers are ideal for use with lay-flat polythene tubing, producing bags to size for product packaging.

Impulse heat sealers use upper and lower heating elements.

This easy to handle heat sealer is designed to seal polythene bags or lay-flat polythene tubing up to 400 mm wide.

The machine comes with a 12-month warranty covering non-consumable parts and labour.

Product Code	Seal Length (mm)
004540	200
004541	300
004542	400



Polythene

## Impulse Heat Sealer

Professional quality impulse heat sealer for use with layflat tubing or plastic bags. Integral film trimming cutter neatly removes surplus film following seal.

Product Code	Seal Length (mm)
004541	300



## Pallet Top Sheets

A protective shield for stretch-wrapped pallets

Custom sizes available  
Call Us

Pallet top sheets are designed to protect stretch-wrapped pallets from wet weather and dust during transit and in storage. A warehouse essential, these tough-wearing sheets are supplied on a perforated roll for easy separation and handling.

To apply the polythene sheet, simply pull the stretch film to the top of the pallet, lay the sheet over, then add a further layer of stretch film, securing the polythene between the layers.

All pallet top sheets are supplied centre folded. The dimensions displayed show the width of the sheet opened out.

Product Code	Duty	Colour	Size (mm)	Sheets Per Roll
223759	Extra Light	Clear	1800 x 1800	500
003084	Standard	Clear	1800 x 1800	150
002694	Heavy	Black	1800 x 1500	150
003083	Heavy	Clear	1800 x 1800	150

Environmental impact rating See page 5



recycle with bags at large supermarkets  
DON'T RECYCLE AT HOME



recyclability category  
LDPE



0% recycled content

## Centrefold Polythene Sheets

Tough cover-all against dust and moisture

These general purpose polythene sheets are designed to protect items in storage from dust and moisture.

Sheets are unperforated to provide maximum value and minimum waste, allowing you to cut to the size you need, for which we recommend using a packing knife.

Supplied centre folded for ease of handling, the polythene sheet dimensions described show the width of the sheet opened out.

Product Code	Duty	Width (m)	Length (m)	Pack Qty
000728	Light	2m folded to 1m	150	1 Roll
000729	Light	4m folded to 2m	75	1 Roll
000311	Medium	2m folded to 1m	100	1 Roll
000312	Medium	4m folded to 2m	50	1 Roll
000315	Heavy	2m folded to 1m	50	1 Roll
000316	Heavy	4m folded to 2m	25	1 Roll



Environmental impact rating See page 5



recycle with bags at large supermarkets  
DON'T RECYCLE AT HOME



recyclability category  
LDPE



0% recycled content

don't forget...

Single wall boxes

SEE PAGE 12



Heat sealers

SEE PAGE 101



Polythene cutter

SEE PAGE 132



Unlined boxes

SEE PAGE 38

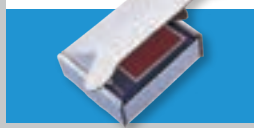

Food Safe

## Polythene LDPE Centrefold Shrinkable Film

Dust, dirt & waterproof protection for transit & storage

LDPE shrink wrap films keep products and pallets dust, dirt and water free during transit and in storage.

Sealing around loads requires a shrink film heat system. A shrink film dispenser is also recommended for fast application and storage of shrink film rolls in use. All LDPE shrink films are supplied on a centre-folded roll for easy use. Dimensions show the width of film opened out.

### Light Duty

Product Code	Roll Width (mm)	Open Width (mm)	Roll Length (m)	Pack Qty
219811	150	1500	120	1 Roll
219814	200	1500	90	2 Roll

### Heavy Duty

Product Code	Roll Width (mm)	Open Width (mm)	Roll Length (m)	Pack Qty
002590	1000	2000	180	1 Roll
219811	1500	3000	120	1 Roll
006648	1800	3600	100	1 Roll
001697	2000	4000	90	1 Roll

### Super Heavy Duty

Product Code	Roll Width (mm)	Open Width (mm)	Roll Length (m)	Pack Qty
001963	1000	2000	135	1 Roll
219814	1500	3000	90	1 Roll

## Shrink Wrap Pallet Covers

Clear cover adds protection from the elements

Shrink wrap pallet covers provide protective cover from wet weather, dirt and dust in transit and storage, while the transparent polythene construction enables easy identification of the contents.

To use, simply place the pallet cover over the pallet, which acts as a bag. Use a heat shrink film gun to shrink the cover to a tight fit for the pallet and contents.

Super heavy-duty shrink film pallet covers are supplied on a roll as gusseted sacks and perforated for easy removal from the roll.

#### To calculate the size of gusseted pallet cover needed, measure:

- Length of pallet load plus 75mm
- Width of pallet load plus 100mm
- Height of pallet Load plus 50% of width plus 100mm



Custom sizes available  
Call Us



Polythene

Product Code	Cover Size (mm)	To Fit Pallet Size (mm)	Open to Dimensions (mm)	Covers Per Roll	Pack Qty
002954	1250 x 2100 x 1700	1200 x 800 x 1200	2100	25	1 roll
006636	1275 x 2350 x 1500	1200 x 1000 x 915	2350	25	1 roll
002953	1275 x 2350 x 1800	1200 x 1000 x 1200	2350	25	1 roll
002952	1275 x 2350 x 2100	1200 x 1000 x 1525	2350	25	1 roll
002951	1400 x 2600 x 1900	1200 x 1200 x 1200	2600	25	1 roll
006640	1400 x 2600 x 2200	1200 x 1200 x 1525	2600	25	1 roll

Environmental impact rating See page 5



recycle with bags at large supermarkets  
DON'T RECYCLE AT HOME



recyclability category  
LDPE



0% recycled content

Local service with national coverage

Wide product range

Next day delivery available

Stock holding and call-off service

## VCI Polythene

We can supply a polythene VCI solution. Contact your local Macfarlane representative for more details.



Environmental impact rating See page 5



don't  
recycle



recyclability  
category  
OTHER



0%  
recycled  
content

## Shrink Wrap Films – Polyolefin

Polyolefin shrink film is not as corrosive as PVC shrink film, and has a higher yield and clarity. It is also stronger, more flexible and can withstand lower storage temperatures.

This product aids machine usability by creating less build up of material on machine sealing wires, whilst being compatible with manual, semi and fully automatic machines.

Another benefit – Polyolefin shrink film does not give off harmful gases which could be hazardous to the environment.



### Light Duty

Product Code	Roll Width (mm)	Open Width (mm)	Roll Length (m)
003290	400	800	1,335
003295	450	900	1,335

### Medium Duty

Product Code	Roll Width (mm)	Open Width (mm)	Roll Length (m)
003302	400	800	1,070
003310	500	1,000	1,070

### Heavy Duty

Product Code	Roll Width (mm)	Open Width (mm)	Roll Length (m)
003305	400	800	800
003313	500	1,000	800
003319	600	1,200	800

Environmental impact rating See page 5



don't  
recycle



recyclability  
category  
OTHER



0%  
recycled  
content



## Economy Shrink Film Gun

**Plus**  
a pair of  
HD gloves

Cost-effective and easy to use, this heating gun includes regulator with safety cut-out and anti-kink swivel joint.

Fitted with eight metres of safety hose.

Full instructions and tool kit included.

Suitable for use with LPDE shrink film and pallet covers.



Product Code	Description
220951	Economy Shrink Film Gun

Complete  
with holster  
for gun

## Gas Cylinder Trolley for Shrink Wrap Gun

\* Gas and gun not included



Product Code	Description
003282	For Use with Shrink Film Gun



Polythene

don't  
forget...

SEE PAGE  
82

Kraft ribbed  
paper

SEE PAGE  
30

Mail Lite®

SEE PAGE  
101

Heat  
sealers

SEE PAGE  
133

Glue  
gun

# Macfarlane Packaging protects...

...more than your  
products



We're doing our part to protect the environment by introducing electric vehicles to our delivery fleet.

## What will you protect?



# Stretch

Different types of film 108

## Products

Hand Applied Stretch Film 110

Hand Applied Dispensers 112

Machine Applied Stretch Film 113

Stretch Wrap Machines 114



Stretch



Local service with national coverage

Wide product range

Next day delivery available

Stock holding and call-off service

# Different types of film

## Blown stretch films

Blown stretch films are typically used for heavier irregular loads and applications requiring excellent puncture and tear resistance.

Additives are used to provide excellent cling and superior load stabilisation characteristics.

As a result, blown stretch films can be noisy as reels are unwound.

## Cast stretch films

Cast stretch films provide a smooth surface with excellent optics, gloss, strength and cling without additives.

## Pre-stretched films

Pre-stretching involves stretching the film during manufacture. The process can increase film strength, improve load stability, reduce the volume of stretch wrap film needed and subsequently save on stretch film packaging costs.

We offer a range of pre-stretched stretch films designed to achieve optimal pre-stretching results that can be used with stretch wrap machines and manual application operations.

Key benefits experienced from using pre-stretched films include: Reduced wastage, Faster wrapping, Improved health and safety.



Scan for stretch wrap review

## Are you using the best film for your requirements?

Before selecting a stretch film, we'd recommend you measure your current usages and review your application.

The best way to calculate your usage is to look at your stretch yield in metres and your yield costs in weight. This enables you to calculate the effectiveness of your stretch wrap by calculating the cost to wrap a pallet.

**Still not sure? Contact us to review your requirements.**



# Selecting the best stretch film for your requirements

When selecting stretch films consider the following:

## Performance

Selecting a stretch film that provides the right yield strength and performance for the loads being wrapped is crucial. The yield strength denotes the amount of stress a stretch film can withstand without permanently having plastic deformation. Prior to reaching the yield point, a stretch film will elastically deform but return to it's original shape once the stress is removed.

	Hand applied Cast Film (mu)	Hand applied Blown Film (mu)	Hand-Applied Pre-Stretched Film (mu)	Machine Film (mu)
Extra Light	-	-	5.5	12
Super Light	-	-	-	15
Light	12	11	-	17
Medium	14	13	-	20
Heavy	16	15	-	23
Super Heavy	19	18	-	30
Ex Super Heavy	28	27	-	-

We've categorised our stretch films by strength:

## Products

Consider the products being wrapped. Also look at the weight load (typically per pallet), the load profile as described below, and the transit process the load will experience.

## Time, Use and Cost Use

Hand wrapping is best suited for smaller or sporadic stretch film wrapping requirements. Introducing machine wrapping may ultimately save time, resources and packaging materials.

## Overlapping

This is a technique for covering the top of your pallet using polythene top sheets (See page 52 for top sheets). This protects your products and provides a downward force on the pallet load. When overlapping hand applied films, it is recommended users allow up to a 50% overlap. If using machine applied films, users should allow a 50 mm overlap, regardless of the film width.

## Banding

This refers to applying multiple wraps of stretch film to a particular area of a pallet to reinforce the load or band multiple units together.

## Neckdown

This happens when a film loses its dispensing roll width and narrows down while being stretched. Neckdown reduces the coverage each wrap provides thereby making it likely that more wrap rotations and more film will be needed to wrap a load or pallet.

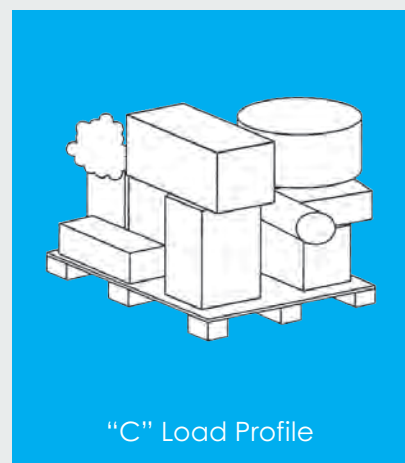



# Stretch

## Hand-Applied Stretch Films

Hand-applied stretch films are used for manual stretch wrap packaging application. All hand-applied stretch films are supplied on standard cores for use with hand-applied applicators or extended cores.

- Always place the outside of the film to the pallet surface
- Secure film to the pallet before wrapping by tying to the pallet base
- Always ensure the film covers the base of the pallet and the bottom layer of the load
- Wrap the bottom of the pallet at least twice to secure load
- Overlap film by 30% to 50%
- Depending on the weight of the load, consider wrapping the pallet twice
- To maximise strength use the film horizontally to create a 'strap'

## Hand-Applied Blown Stretch Film

### Clear Films\*

Product Code	Core	Strength	Size (mm x m)	Rolls Per Case	Pallet Qty
001217	Standard	Light	400 x 300	6	450
000437	Standard	Medium	400 x 300	6	360
000092	Extended	Medium	400 x 300	6	300
003152	Standard	Medium	500 x 300	6	240
000247	Standard	Heavy	400 x 300	6	360
001980	Extended	Heavy	400 x 300	6	300
003156	Standard	Heavy	500 x 300	6	240
004821	Standard	Super Heavy	400 x 300	6	360
000897	Standard	Extra Heavy	400 x 200	6	360

### Black Films\*\*

Product Code	Core	Strength	Size (mm x m)	Rolls Per Case	Pallet Qty
001140	Standard	Heavy	500 x 250	6	240
256303	Standard	Super Heavy	500 x 250	6	240



Environmental impact rating See page 5

\*Clear Films \*\*Black Films



recycle with bags at large supermarkets  
DON'T RECYCLE AT HOME



recyclability category  
LDPE



minimum recycled content \*



less than recycled content \*\*

## Hand-Applied Blown Pre-Stretched Film

Reduced waste with increased strength and better load stability.

Product Code	Core	Strength	Size(mm x m)	Rolls Per Case	Pallet Qty
279099	Extended	Light	390 x 600	N/A	300
278914	Standard	Light	390 x 600	N/A	300
304733	Extended	Light	390 x 600	6	270

Environmental impact rating See page 5



recycle with bags at large supermarkets  
DON'T RECYCLE AT HOME

recyclability category  
LDPE

0% recycled content

## Hand-Applied Cast Stretch Films

A strong stretch film without additives, that clings only to itself and is quieter to use than other films. Prevents products on pallets from moving in transit. Cast stretch wrap is suitable for food products.

### Hand-Applied Cast Stretch Films

Product Code	Core	Strength	Size (mm x m)	Rolls Per Case	Pallet Qty
00355	Extended	Medium	400 x 300	6	240
002172	Standard	Medium	400 x 300	6	240
002133	Standard	Medium	500 x 300	6	240
000195	Standard	Heavy	400 x 300	6	240
000196	Standard	Heavy	500 x 300	6	240
000350	Extended	Heavy	400 x 300	6	240
001943	Standard	Super Heavy	400 x 300	6	240
007919	Standard	Super Heavy	500 x 300	6	240
007918	Standard	Extra Super Heavy	500 x 150	6	240

Environmental impact rating See page 5



recycle with bags at large supermarkets  
DON'T RECYCLE AT HOME

recyclability category  
LDPE

30% minimum recycled content



Stretch

don't forget...

SEE PAGE  
82  
Kraft ribbed paper



SEE PAGE  
30  
Mail Lite®



SEE PAGE  
101  
Heat sealers



SEE PAGE  
133  
Glue gun



Local service with national coverage

Wide product range

Next day delivery available

Stock holding and call-off service

## Hand-Applied Stretch Film Dispenser

For use with 400 or 500mm width films and 38 or 50mm ID Cores.  
Suitable for use with blown or cast films.

Product Code	Description	Unit
001044	Hand-Applied Stretch Film Dispenser	1



## Handywrap Starter Kit

Product Code	Application	Unit
004443	Use with standard core cast stretch film 100mm x 150m	20 rolls + 2 Dispenser handles



## Handywrap Mini Reel

Easy application for bundling and wrapping small items.

### Cast

Product Code	Core	Strength	Size (mm x m)	Rolls Per Case
003793	Extended	Light	100 x 150	40

### Blown

Product Code	Core	Strength	Size (mm x m)	Rolls Per Case
006910	Extended	Medium	100 x 150	40



## Handywrap Applicator Handle

Product Code	Application	Unit
003789	Use with standard and extended handywrap mini reels	1

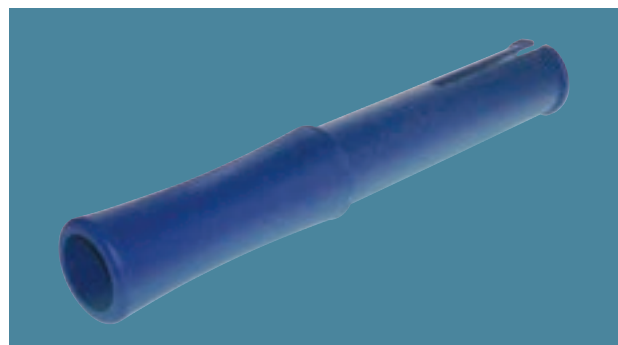

## Machine Applied Stretch Films

Machine applied stretch films are extremely strong and versatile, saving time, resources and packaging materials for high performance applications requiring higher tensile strengths. These films have excellent puncture resistance, good cling, slip and load retention.

Cast stretch wrap films provide a smooth surface with excellent clarity, gloss, strength and cling, without additives. Machine-applied stretch films are suitable for use on power pre-machines up to 250% stretch.



## Power Pre-Cast Stretch Film

Smooth-action clarity, gloss, strength and cling, with no additives.

Product Code	Core (mm)	Strength	Stretch (%)	Size(mm x m)	Pallet Qty
000686	75	Extra Light*	250	500 x 2800	46
275639	75	Super Light*	250	500 x 2100	46
001560	75	Light*	200	500 x 2000	46
235877	75	Light*	250	500 x 2000	46
002468	75	Medium**	200	500 x 1700	46
235878	75	Medium**	250	500 x 1700	46
009095	75	Heavy**	200	500 x 1500	46
235880	75	Heavy**	250	500 x 1500	46
001746	75	Super Heavy**	200	500 x 1100	46

Environmental impact rating See page 5

\*Extra Light, Super Light \*\*Light, Medium, Heavy and Super Heavy



recycle with bags at large supermarkets  
DON'T RECYCLE AT HOME



recyclability category  
LDPE



recycled\* content



minimum\*\* recycled content

## Black Cast Stretch Film

Up to 200% stretch. Suitable for use on core brake and power pre-machines.

Product Code	Core (mm)	Strength	Size (mm x m)	Pallet Qty
001232	75	Heavy	500 x 1500	46

Environmental impact rating See page 5



recycle with bags at large supermarkets  
DON'T RECYCLE AT HOME



recyclability category  
LDPE



minimum recycled content

## Machine Pre-Stretch Film

Faster wrapping, with improved load holding and reduced waste.

Product Code	Core (mm)	Strength	Size (mm x m)	Pallet Qty
262997	75	Light	430 x 3500	48

Environmental impact rating See page 5



recycle with bags at large supermarkets  
DON'T RECYCLE AT HOME



recyclability category  
LDPE



recycled content



# Stretch automation

If you are wrapping 15 pallets or more per day, it may be time to consider stretch automation. We offer a full range of solutions.

## Ecoplatt Plus FRD Base Stretch Wrapping Machine

- Entry level machine
- Removes stress and strains of manual pallet wrapping
- 1650mm turntable
- 2200mm wrap height



Larger Turntable Options	N
Higher Wrap Height Options	Y
Turntable Capacity	2000kg
Automatic Pallet Height Sensor	Y
Indexed Stop Position	Y
Variable Carriage Speed	Y
Variable Rotation Speed	Y
Variable Tension	Y
Power-Pre Stretch	N/A
No of Pallets per Day	Up to 10
Film Type	Standard / Pre-Stretch

## Masterplat Plus PGS Power-Pre Stretch Wrapping Machine

- Entry level Power Pre-Stretch machine
- Suitable for use with light, crushable goods
- Reduce film usage
- Improve pallet stability
- For use with 250% Power Pre-Stretch Film
- 2200mm Wrap Height
- 1650mm Turntable



Larger Turntable Options	Y
Higher Wrap Height Options	Y
Turntable Capacity	2000kg
Automatic Pallet Height Sensor	Y
Indexed Stop Position	Y
Variable Carriage Speed	Y
Variable Rotation Speed	Y
Variable Tension	Y
Power-Pre Stretch	250%
No of Pallets per Day	20 or more
Film Type	Power Pre-Stretch



## Rotoplat 508PDS Stretch Wrapping Machine

- Suitable for use with light, crushable goods
- 1650mm Turntable
- 2200mm Wrap Height
- For use with 250% Power Pre-Stretch Film
- Touch screen control panel
- 12 program pre-set



Larger Turntable Options	Y
Higher Wrap Height Options	Y
Turntable Capacity	2000kg
Automatic Pallet Height Sensor	Y
Indexed Stop Position	Y
Variable Carriage Speed	Y
Variable Rotation Speed	Y
Variable Tension	Y
Power-Pre Stretch	250%
No of Pallets per Day	20 or more
Film Type	Power Pre-Stretch

## Robot Master PDS Power-Pre Stretch Wrapping Machine

- Suitable for use with light, crushable goods
- For use with 250% Power Pre-Stretch Film



Larger Turntable Options	N/A
Higher Wrap Height Options	Y
Turntable Capacity	N/A
Automatic Pallet Height Sensor	Y
Indexed Stop Position	N/A
Variable Carriage Speed	Y
Variable Rotation Speed	Y
Variable Tension	Y
Power-Pre Stretch	250%
No of Pallets per Day	20 or more
Film Type	Power Pre-Stretch



Stretch

don't forget...

SEE PAGE 98  
Tape dispenser

SEE PAGE 12  
Single wall boxes

SEE PAGE 132  
Packing opener

SEE PAGE 74  
Loosefill

Local service with national coverage

Wide product range

Next day delivery available

Stock holding and call-off service

# Macfarlane Packaging protects...

...margins

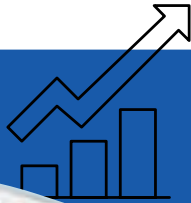

with just in time delivery from our distribution network

...the planet



with recyclable packaging made from 50% recycled content

...reputations



with industrial packaging for tough transit conditions

...brands



with packaging that creates a rewarding unboxing experience

## What will you protect?



# Strapping

## Products

Hand Applied Strapping	118
Hand Applied Strapping: Tools and Accessories	119
Polypropylene Machine Strapping	122
Polyester Strapping	122
Strapping Machines	123
Corded Polyester Strapping	123
Steel Strapping	124
Steel Strapping: Tools and Accessories	125



Strapping



Local service with  
national coverage

Wide product range

Next day delivery  
available

Stock holding and  
call-off service

# Strapping

Custom options available  
Call Us

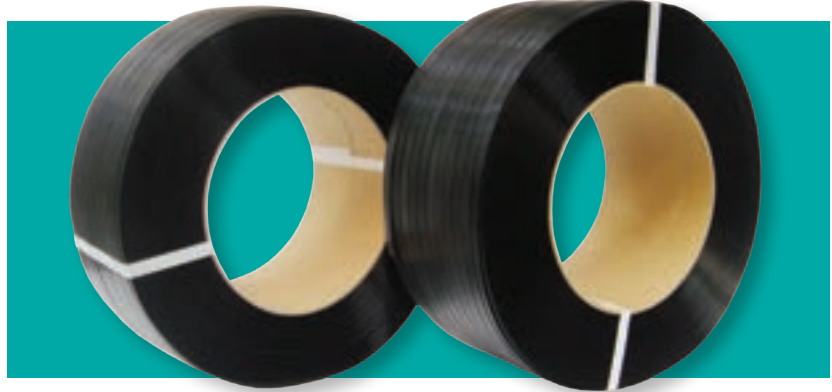

## Polypropylene Hand Strapping on Cardboard Cores

Macfarlane strapping is ideal for bundling products together or strapping pallets.

Available in medium, heavy or super heavy duty and can be used with a designated stand.

Product Code	Size (mm x m)	Core Size (mm x mm)	Strength	Approx. Breaking Strain (kg)	Pack Qty
007469	12 x 1500	200 x 150	Medium	175	2
007467	12 x 1000	200 x 150	Heavy	220	2
000022	16 x 800	200 x 150	Super Heavy	310	2

Environmental impact rating See page 5



don't recycle



recyclability category PP



minimum recycled content



## Strapping Dispenser Trolley

The ideal dispenser for strapping supplied with a cardboard core. Wheel-mounted for mobility in situ.

Product Code	Description	Pack Qty
000018	Suitable for use with 200mm cardboard core strapping	1

## Hand Strapping Starter Kit

All you need to start a secure strapping system.

The hand-applied strapping kit is a cost-effective way to buy strapping products and accessories.

Replacement polypropylene strapping and seals are available to order when you have used up the initial supply.

The kit includes:

- 12 mm tensioner and sealer
- 1 reel of 12 mm x 1500 m
- Polypropylene strapping
- On plastic reel
- 1 dispensing stand
- 500 seals

Product Code	Description
218283	Hand Strapping Kit

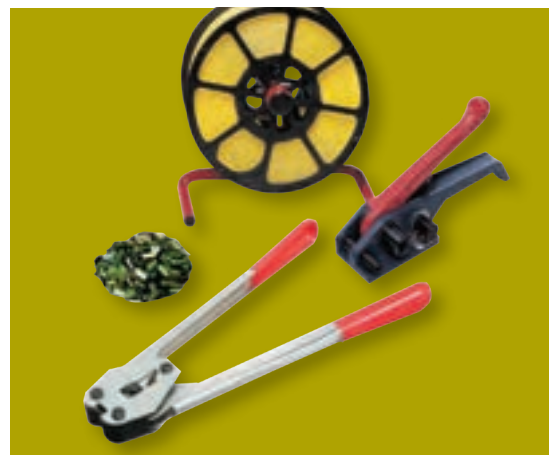



Custom printing available  
Call Us

## Polypropylene Hand Strapping on Plastic Reels



Hand-applied polypropylene strapping delivers dependable performance. Holds tight and firm making it ideal for a variety of packaging operations. Available in medium, heavy or super heavy duty and can be used with a designated stand.

Product Code	Size (mm x m)	Strength	Approx. Breaking Strain (kg)	Pack Qty
007471	12 x 2200	Light	115	2
007470	12 x 1800	Medium	175	2
007466	12 x 1400	Heavy	205	1
007468	12 x 1200	Super Heavy	220	2

Environmental impact rating See page 5



don't recycle



recyclability category PP



50% minimum recycled content



## Dispensing Stand For Plastic Reels

Handy dispenser, with inbuilt stand and hand-grip, for polypropylene strapping on a plastic reel.

Product Code	Description	Pack Qty
001849	For use with plastic core strapping	1

## Strapping Dispenser Trolley

Pull-along dispenser for plastic reels, on a sturdy stand, including useful tray for tools and seals.

Product Code	Description	Pack Qty
001115	For use with plastic core strapping	1



Strapping

Local service with national coverage

Wide product range

Next day delivery available

Stock holding and call-off service



## Plastic Edge Protectors

These wrap-around plastic edge protectors are designed for use with polypropylene and polyester strapping.

Product Code	Size (mm)	Pack Qty
001311	25 x 25	2,000
001310	40 x 40	1,000



## Buckles

The simple buckle device secures polypropylene or polyester strapping by pulling the strapping through the buckle. Available in metal or plastic, buckles offer an alternative to seals with low tension. A tensioner tool is required.

Product Code	Description	Pack Qty
001307	Plastic Buckles (12 mm)	2,000
001312	Metal Buckles (12 mm)	1,000
001313	Metal Buckles (16 mm)	1,000



## Seals

A range of semi-open and serrated seals for use with polypropylene and polyester hand strapping.

Semi open strapping seals allow the seal to be placed along the strapping for secure sealing. Seals must be applied with sealer and strapping tensioner or combination tool.

Serrated strapping seals have serrated teeth on the inside of the seal, allowing serrated seals to grip strapping securely and improve the breaking strain.

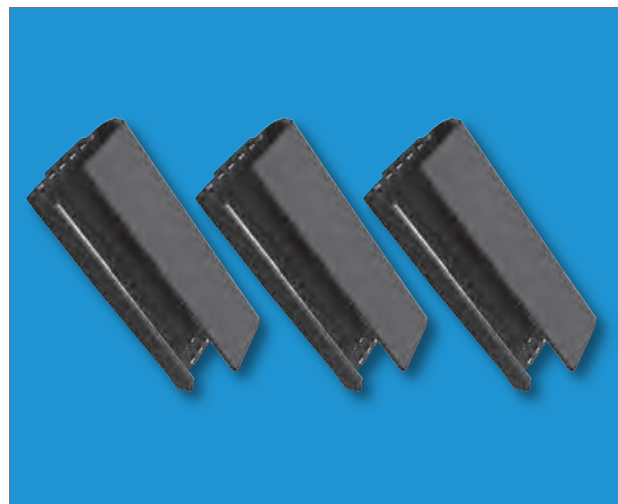

Product Code	Seal Type	Size (mm)	Suitable Strapping	Suitable Sealing Tool	Pack Qty
002733	Standard Semi-Open	12 x 25	12mm Polypropylene	Economy Combination Tool	2000
002745	Heavy Semi-Open	12 x 32	12mm Polypropylene or Polyester	ST-IMPA Combination Tool	2000
001316	Heavy Semi-Open	16 x 32	16mm Polypropylene or Polyester	ST-IMPA Combination Tool	2000
000017	Serrated	12 x 30	12mm Polypropylene or Polyester	ST-IMPA Combination Tool	1000
001332	Serrated	16 x 30	16mm Polypropylene or Polyester	ST-IMPA Combination Tool	1000

## Standard Tensioner Tool

Gain a tight fit on strapping with this standard tensioner tool that can be used vertically or horizontally.

For use with polypropylene strapping up to 16mm wide. A sealing tool is also required.

Product Code	Description
001549	Use up to 16mm Strapping



## Standard Sealer Tool 12mm

Long handled sealing jaws allow maximum seal strength to be achieved with minimum physical effort.

Product Code	Description
001552	Use 12 mm Strapping
000669	Use 16 mm Strapping



## Combination Tools

Versatile, all-in-one strapping tools that enable you to tension, seal and cut strapping in one action.

Product Code	Description	Use with
000805	Economy Combination Tool	12mm Strapping
000491	ST-IMPA Combination Tool	Up to 16mm Strapping

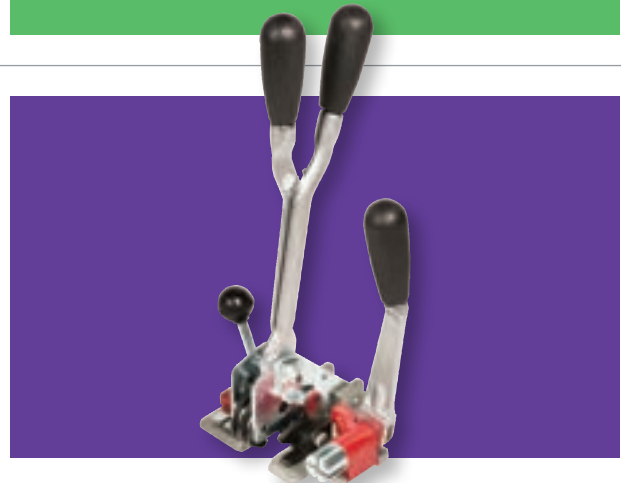

## Friction Welder

Battery Strapping Tool with adjustable functioning mode which can be set as Automatic, Semi-automatic, Manual and "Soft". Easy to use and simple to adjust it can be used for both vertical and horizontal strapping. It tensions, cuts and seals at the touch of a button.

Product Code	Description	Model Number
220963	Friction Welder	GT-SMART



Strapping

Other colours available  
Call Us

For strapping machines  
See page 158



## Polypropylene Machine-Applied Strapping

Machine-applied polypropylene strapping is ideal for bundling products, magazines/newspapers and packages together, or securing individual cardboard boxes.

Light, flexible and easy to handle, it offers excellent performance and reliability for most strapping tasks, with no staining or rusting of the product or package.

Manufactured in white and supplied on a cardboard core, with approximate breaking strains from 100 to 135kg. Available in semi-auto and fully-auto machine formats.

Product Code	Strapping Application	Length (m)	Width (mm)	Strapping Thickness	Approx. Breaking Strain (kg)	Core (mm)	Pack Qty
001017	Semi-Auto Machine	3700	9	0.55	100	200 x 190	2
000693	Semi-Auto Machine	2700	12	0.55	135	200 x 190	2
121740	Fully-Auto Machine	3000	12	0.55	145	200 x 190	2

Environmental impact rating See page 5



don't recycle



recyclability category PP



minimum recycled content

Custom printing available  
Call Us

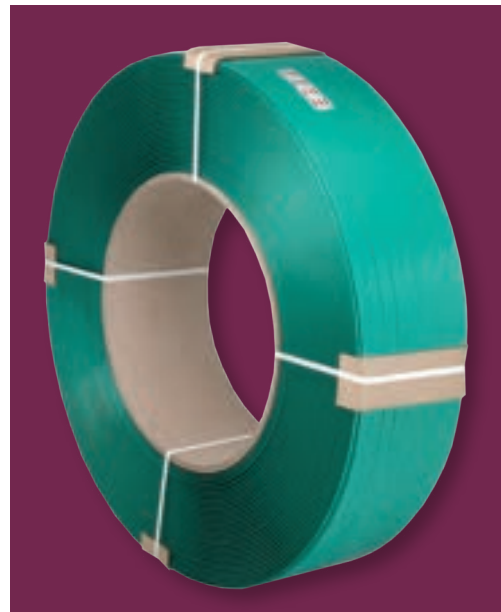

## Hand-Applied Polyester Strapping

Polyester strapping is an extremely strong, yet soft, lightweight and weather-resistant alternative to steel strapping.

Polyester strapping takes 2.5 times more energy to break than steel strapping with the same break strain. An 'elastic memory' maintains tension even where there is pack settlement or shrinkage.

There are no sharp edges, creating a safer working environment and also reducing the potential for product damage compared with steel strapping.

Product Code	Description	Length (m)	Width (mm)	Strapping Thickness	Approx. Breaking Strain (kg)	Core (mm)	Pack Qty
001340	Hand-Applied	2500	12	0.06	310	406 x 152	1
007889	Hand-Applied	1500	15.5	0.07	450	406 x 152	1

Environmental impact rating See page 5



don't recycle



recyclability category PETE



minimum recycled content

## Hand-Applied Corded Polyester Strapping

A soft, lightweight, strong and weather-resistant alternative to steel strapping. With textured finish for ultra-firm grip.



Product Code	Width (mm)	Length (m)	Approx. Breaking Strain (kg)	Pack Qty
004745	13	1500	380	1
004746	16	1200	460	1

Environmental impact rating See page 5



don't recycle



recyclability category PETE



30% minimum recycled content

## Strapping machines

We can offer a full range of semi and fully automated strapping machines. Below is just a small selection. If you are looking for something different, please contact us.



Product Code	Type	Comments
331697	iQ-400 Semi-Automatic Strapping Machine	Runs PP strap from 5 - 15.5mm
331336	SQ-800 Automatic Strapping Machine	Takes strapping thicknesses of 5, 6, 9, 12, 15.5 mm
331698	OB-360 N Automatic Banding Machine	Versatile - 30mm banding, either paper or film tape
331700	JK-5000 Automatic Strapping Machine	Runs strap from 9mm to 12mm width with easy change over
337786	Type D-53PLT2 Semi-Auto Pallet Strapping Machine	For use with standard or heavier PP strapping

don't forget...

SEE PAGE 98  
Tape dispenser

SEE PAGE 14  
Double wall boxes

SEE PAGE 46  
Bubble wrap

SEE PAGE 95  
Printed warning labels

Local service with national coverage

Wide product range

Next day delivery available

Stock holding and call-off service



## Ribbon Wound Steel Strapping

Steel is traditionally the strongest type of strapping available and remains widely within the construction sector. It has the highest tensile strength of any strapping material.



Product Code	Width (mm)	Length (m)	Approx. Breaking Strain (kg)	Pack Qty
000412	13	330	518	1
000425	16	334	652	1
000432	19	334	775	1

Environmental impact rating See page 5



recycle



recyclability category  
FE



0% recycled content

## Ribbon Wound Dispenser Trolley

Robust wheeled trolley designed for use with ribbon wound steel strapping from 13mm to 19mm wide.



Product Code	Description
001238	Ribbon Wound Dispenser Trolley

## Snap On Seals

Snap on strapping seals are designed for use with steel strapping and provide a semi open seal, which snaps on to hold the strapping securely in place.

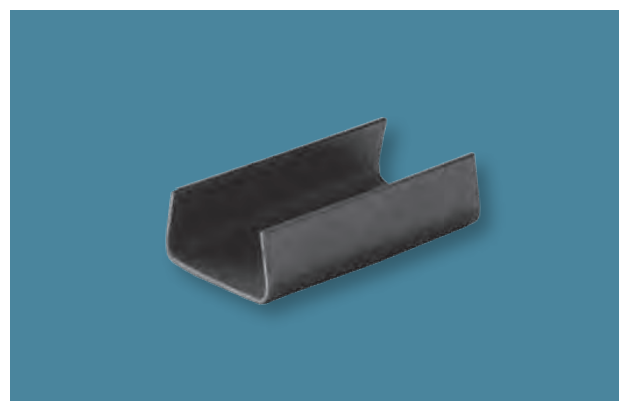

Product Code	Width (mm)	Pack Qty
001224	13	1000
001226	16	1000
001227	19	1000



## Oscillated Steel Strapping

Steel strapping wound in a tight, uniform pattern for added strength.

Product Code	Width (mm)	Length (m)	Approx. Breaking Strain (kg)	Pack Qty
004824	13	965	518	1
005196	16	763	652	1
003141	19	533	930	1



Environmental impact rating See page 5



recycle



recyclability category  
40% FE



0% recycled content

## Oscillated Steel Strapping Dispenser Trolley

Wheel-along trolley accommodates steel strapping reels from 13mm to 19mm wide, for easy packing in situ.

Product Code	Description
002707	Oscillated Steel Dispenser Trolley



## Overlap Seals

Closed seals for use with up to 19 mm steel strapping.

Product Code	Width (mm)	Pack Qty
001416	13	1000
001417	16	2500
001418	19	2000



Strapping

Local service with national coverage

Wide product range

Next day delivery available

Stock holding and call-off service

## Steel Strapping Sealer Tool

Easy-grip, essential tool specially designed for use with steel strapping.

Product Code	Description	Pack Qty
001233	For use with Steel Strapping up to 13 mm	1
001234	For use with Steel Strapping up to 16 mm	1
001235	For use with Steel Strapping up to 19 mm	1



## Steel Strapping Safety Cutter

Strong, high-performance safety cutters designed for use with steel strapping.

Product Code	Description
001237	For use with Steel Strapping



## Steel Strapping Tensioner Tool

A handy tool that creates the right, tight fit for steel strapping.

Product Code	Description
001236	For use with Steel Strapping



## ST-IMAG Combination Tool

This high quality combination tensioning and sealing device is designed for use with 13mm, 16mm and 19mm steel strapping, to a maximum gauge of 0.6mm.

Product Code	Description
004404	For use with 12mm Steel Strapping
000663	For use with 16mm Steel Strapping
000668	For use with 19mm Steel Strapping





## Packing room and warehouse accessories

### Products

Shelving	128
Labels	129
Anti-Fatigue Mats	130
Shock watches	130
Packing Stations	130
Do Not Stack Cones	131
Warehouse Accessories	131
Glue Guns & Adhesives	133



Accessories

Local service with national coverage

Wide product range

Next day delivery available

Stock holding and call-off service

# Accessories

## Industrial Shelving

Solid storage designed for heavy loads

High quality, strongly constructed industrial shelving provides generous storage, designed to support heavy loads.

We offer a range of bolt free, easy to assemble shelving systems, with up to 5 shelves. Shelves slot easily into place with wide gaps between each tier to accommodate bulky boxes, tools and equipment. Ideal for warehouse, packing room and all industrial environments.

Load capacity varies from 175kg – 300kg; please refer to the product table below.

When assembling the shelving a rubber mallet is the best tool to be used.

Product Code	Size mm (H x L x W)	Max Load (kg)	Shelves	Pack Qty
001281	1760 x 900 x 300	175	5	1
001250	1760 x 900 x 450	175	5	1
001277	1760 x 900 x 600	175	5	1
001147	1760 x 900 x 300	265	5	1
001223	1760 x 900 x 450	265	5	1
001325	1760 x 900 x 600	265	5	1
001326	1760 x 1200 x 450	265	5	1
001112	1800 x 1200 x 600	265	5	1
001100	1800 x 1500 x 600	265	5	1
001128	1830 x 1830 x 455	420	3	1
001331	1830 x 1830 x 610	420	4	1
001299	1980 x 1525 x 610	640	4	1



## Shelving Bay Connectors

Firm support for your shelving system

Used to secure and hold multiple shelving units in place.

In packs of six, to support 150kg load to 300kg load. Galvanised to prevent rusting.

Product Code	Description	Pack Qty
001249	Joining Pins for 175kg/265kg Shelving	4
2000374	Tie Plates for 420kg/640kg Shelving	4



## Chrome Shelving

Polished stacking, ideal for display

This multi-purpose, bolt-free wire shelving with an attractive chrome finish will slot into most working environments and is ideal both for display and storage.

The four open tiers provide free airflow, preventing moisture build up.

Product Code	Size mm (H x L x W)	Max Load (kg)	Shelves	Pack Qty
007236	1625 x 1830 x 610	150	4	1
001130	1600 x 1220 x 355	175	4	1
001327	1600 x 1220 x 455	175	4	1
001261	1600 x 1220 x 610	175	4	1
001354	1600 x 915 x 355	200	4	1
001231	1600 x 915 x 455	200	4	1
001330	1600 x 915 x 610	200	4	1



## Shelf Labels and Card Inserts

Spot-on identity check

Macfarlane shelf-edge labels allow quick and easy identification of locations on shelving and pallet racking.

In a choice of self-adhesive or magnetic backings the labels come with a handy, pull-away front for easy loading and amending information.

Self-adhesive labels provide permanent fixing. Magnetic backed labels offer flexibility of location and are also effective in cold storage areas.

Barcodes can be easily scanned through the clear plastic front without removal.



Product Code	Type	Size (mm)	Pack Qty
001396	Self Adhesive	38 x 100	100
001397	Magnetic	38 x 100	100

Custom labels available  
Call Us

## Printed warning labels

Product Code	Print type	Label Size (mm)	Quantity per roll
002894	ARROWS	100 x 150	250
002893	FRAGILE	100 x 150	250
002892	FRAGILE	150 x 50	250
002891	GLASS WITH CARE	150 x 50	250
002890	THIS WAY UP	150 x 50	250
002895	FRAGILE	87.5 x 37.5	2000

## White address labels

Product Code	Label Size (mm)	Quantity per sheet
003089	200 x 144	100
003088	200 x 288	100
003099	64 x 38	100
003091	99 x 144	100
003094	99 x 38	100
003093	99 x 68	100

Local service with national coverage

Wide product range

Next day delivery available

Stock holding and call-off service



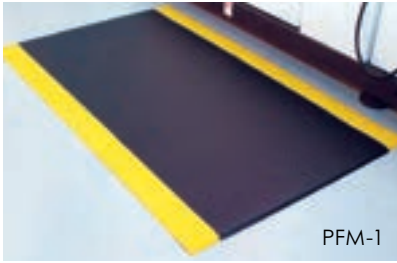

PFM-1



PFM-2



PFM-3

## Anti-fatigue Mats

Black PVC anti-fatigue mat with raised diamond tread pattern surface for improved grip and high-visibility yellow edge.

Suitable for floors in work room and work areas with an increased risk of slipping due to oil or water-based contamination.

Product Code	Reference Number	Dimensions (mm)	Thickness (mm)
261816	PFM-1	900 X 1500	9
258420	PFM-2	900 x 1500	12.5
301838	PFM-3	900 x 1500	14

## Standard Packing Station

This multi-purpose packing station incorporates a broad workbench, plus three sturdy shelves, and is ideal for completing the packaging process. The floor and shoulder-level shelves add storage for packing tools and materials.

Can accommodate loads of up to 200kg.



Product Code	Size mm (H x L x W)	Max Load (kg)	Shelves	Pack Qty
001137	1675 x 1830 x 760	300	4	1
001522	1525 x 1220 x 915	300		1

## Shockwatch

These self-adhesive labels are applied directly to the package and, after activation, will turn from clear to red, indicating any mishandling of the product. Available in a range of five coloured sensitivity levels.

Product Code	Description	Pack Qty
003237	Companion Labels for Shockwatch	100 units

### Shockwatch Indicators

Product Code	Colour	G Sensitivity	Pack Qty
003236	Yellow	25	50
003234	Purple	37.5	50
003235	Red	50	50
000255	Orange	75	50
004874	Green	100	50



## Do Not Stack Cones

Do Not Stack Cones are an effective way to prevent shipping and storage damage by easily identifying and stopping the pallet of goods being stacked. Simply secure the cone with strapping or tape.

Product Code	Description	Pack Qty
216142	Do Not Stack Cones	25



## Floor Markers

- Permanent Adhesive
- High visibility floor graphics to highlight warnings and operational hazards
- Graphics printed on the underside of a clear PVC film
- Signs withstand everyday warehouse traffic
- 450mm diameter

Product Code	Description	Pack Qty
283337	Floor Marker 430mm dia. Forklift Truck Area	1
283338	Floor Marker 430mm dia. Pedestrian Traffic	1
283339	Floor Marker 430mm dia. Fire Exit	1



## Rack Sacks

- Simple fixing and trouble-free handling, supplied with two strong "S" hooks
- Suitable for shelving 900mm to 1100mm deep
- Made from tough waterproof polyester with carrying and emptying handles
- Special prints including company names and logos can be printed. Call for information

Product Code	Description	Pack Qty
297511	Blue Racksack, each - General Waste	1
300684	Blue Racksack, each - Mixed Paper and Card	1



## Packing Station Sack

- Easily organises waste packaging materials
- Fits by hooking over the sides or can also be secured via eyelets in the top corner
- Manufactured from tough woven polyester
- Suits trolleys up to 580mm wide
- Single pocket – 600 x 600 with a capacity of 50L
- Double pocket – 600 x 600 with a capacity of 55L

Product Code	Description	Pack Qty
283342	Single Pocket Trolley Sack, Single Unit	1
283345	Double Pocket Trolley Sack, Single Unit	1
283343	Self-Adhesive Fixing Hooks	2
283344	Self-Adhesive Fixing Hooks	10

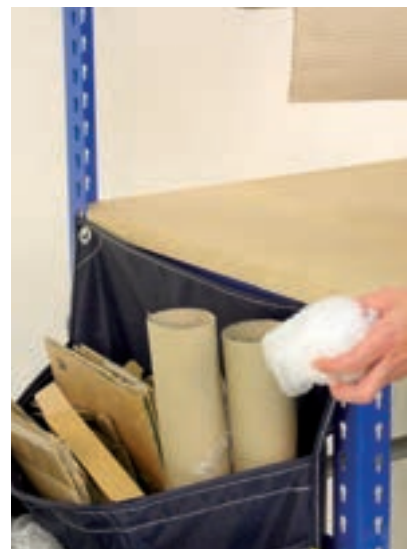

## Packing Opener

A safety-first cutter with highly visible red handle, ideal for cutting stretch and shrink film, polypropylene strapping, bubble wrap and tape. Includes a special blade cover to shield against injury.

Product Code	Pack Qty
001252	10



## Polythene Cutter

Ideal for cutting polythene.

Product Code	Pack Qty
004771	12

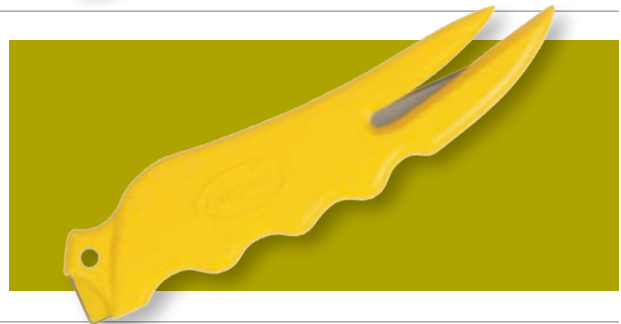

## Retractable Packing Knife

This metal retractable packing knife features a high quality, red, die-cast handle to stand out from surrounding boxes. Supplied with three heavy-duty standard blades.

Product Code	Pack Qty
005399	10



## Retractable Snap-Off Packing Knife

A simple, effective cutting tool, ideal for stripping off packaging. Made from impact-resistant plastic. Features a pocket clip and blade snap-off device. A sliding ratchet adjusts the segmented blades.

Product Code	Pack Qty
005437	10



## Box Corner Safety Cutter

Ideal for cutting multi-depth boxes to required height.

Product Code	Description	Pack Qty
214468	Box Corner Safety Cutter	1
219116	Replacement Blades	100



## Glue Guns & Adhesives

Gain speedy and accurate application with staying power, using this high performance range of glue guns.

Hot melt glue guns are essential to heat glue to melting point, applying adhesion to the exact spot, swiftly and with maximum ease.

All hot melt glue guns come with a 12-month guarantee and full after-sales service when used with hot melt glue sticks supplied by Macfarlane.

The **SL120** Glue Gun uses 12mm glue stick and operates at 240V.

- Dispenses 12mm hot melt up to 33g/min
- With 'power-on' LED light display
- Comfortable grip and long trigger for added operator comfort
- Stick Size: 12 mm

Product Code	Pack Qty
251389	1



The **SL300** Glue gun uses 12mm glue stick and operates at 240V.

- Industrial tool dispenses 12mm hot melt up to 1500g/Hr
- Easy change thermostat values for low melt glues
- Ergonomic design with 'soft feel' handle and adjustable trigger stroke
- Glue adjuster screw for controlled glue dosage
- Stick Size: 12mm

Product Code	Pack Qty
251391	1



The **GX600** High output glue gun, variable operating temperature, uses 43mm glue sticks and operates at 240V.

- High capacity 250ml glue chamber
- Magnetised foot for stability when not in use
- Temperature control dial to suit glue type and application
- Requires no compressed air supply and is ergonomic and lightweight

Product Code	Pack Qty
251394	1



Tacky when heated, setting fast when cool, hot melt glue is an effective adhesive that hardens within just a few seconds of application, providing a tough, resistant bond. Commonly used in manufacturing, woodwork and art and craft hobbies, hot melt glue is also an effective alternative to packing tapes for sealing cardboard boxes.

**Warning:** Hot melt glues can scald, causing burning and blisters. Always check the heat sensitivity of material before applying.

Product Code	Adhesive Colour	Description	Use with	Size (mm)	Unit (kg)
000332	Clear	Fast setting adhesive	SL120 Glue Gun	12 x 300 Stick	5
000323	Brown	Fast setting adhesive	SL300 Glue Gun	12 x 300 Stick	5
000343	Brown	Fast setting adhesive	GX600 Glue Gun	43 x 43 Cartridge	5



# The Packaging Optimiser protects your profit and the environment



The Packaging Optimiser from Macfarlane Packaging can help you protect margins and the environment by eliminating the hidden costs in your packaging operation.



Find out what your packaging operation is really costing your business and the planet

[macfarlanepackaging.com/optimiser](http://macfarlanepackaging.com/optimiser)

## What will you protect?



# Product Index

## A

<b>Accessories Section</b> .....	<b>127</b>
Adhesives .....	133
Air Cushioning and Voidfill .....	60 - 61
AirCap® Bubble Wrap .....	44
AirCap® Anti-Static .....	46
AirCap® Bubble Bags .....	47
AirCap® BubbleGuard .....	48

AirCap® BubbleMask™ .....	48
Airsac® Wine and Beer Packaging .....	49
Airsac® Electronics Packaging .....	50
Airsac® Pharmacy Packaging .....	51
Airsac® Frames .....	52
Airsac® Jars & Mugs .....	52
Airsac® Roll and Inflation Tools .....	53

Airsac® Tins .....	52
Anti-Corrosion Kraft Paper .....	83
Anti-fatigue Mats .....	130
Anti-Static Bubble Wrap .....	46

## B

<b>Bags Section</b> .....	<b>21</b>
BDCM Boxes .....	17
Bio Loosefill .....	74
Black Cast Stretch Film .....	113
Blown Stretch Films .....	110
Bottle Packaging .....	40 - 42

Box Corner Safety Cutter .....	132
<b>Boxes Section</b> .....	<b>9</b>
Brown Paper .....	27
Bubble Bags .....	47
Bubble Lined Bags .....	47
Bubble Lined Envelopes .....	30

BubbleMask™ .....	48
Bubble Wrap .....	44
BubbleGuard® .....	48
Buckles .....	120

## C

Card Inserts .....	129
Cardboard Boxes .....	9
Cardboard Edge Protectors .....	76
Carrier Bags .....	27
Cast Stretch Films .....	111
CD Mailing Pack .....	52
Cell-Aire® Polyethylene Foam .....	62

Centrefold Polythene Sheets .....	120
Centre Feed Hand Rolls .....	83
Cloth Tapes .....	97
Coloured Tapes .....	94
CooliMate® .....	19
Combination Tools .....	121
Component Packs .....	40

Cones .....	131
Copier Paper .....	84
Corded Polyester Strapping .....	123
Corner Protectors .....	76
Corrugated Single Faced Paper .....	80

## D

Do Not Stack Cones .....	131
Document Wallets .....	34

Double Sided Tapes .....	97
Double Wall Boxes .....	14

## E

Eco Tape .....	91
eCommerce Box .....	37
eCommerce Crash-Lock .....	36
eCommerce Transit Box .....	37

eCommerce Range .....	37
Edge Protectors .....	76
Envelopes .....	35
Euro Pallet Boxes .....	16

Electronic Gummed Paper Tape Dispenser ...	93
Ecoplat Plus Base Stretch Wrapping Machine .....	114
Economy Shrink Film Gun .....	105
Enviroflute .....	32



## F

FillPak Fanfold Paper . . . . .	70	FillPak SL® . . . . .	69	Foam Edge Protectors . . . . .	77
Filla Paper Roll . . . . .	81	FillPak TT® . . . . .	69	Foam Lined Postal Boxes . . . . .	39
Filament Tapes . . . . .	96	Films . . . . .	110 - 111	Foam Lined Postal Sleeves . . . . .	39
Fill-Air® RF . . . . .	56	Floor Marking Tapes . . . . .	98	Folding Cartons . . . . .	36
Fill-Air Rocket® . . . . .	56	Floor Marking Tape Applicator . . . . .	98	Friction Welder . . . . .	121
FillPak® . . . . .	69 - 70	Foam Wrap . . . . .	62	Flexi-Hex® . . . . .	41
FillPak TT with Cutter® . . . . .	69	Foam Corner Protectors . . . . .	76		
FillPak M® . . . . .	69	Foam Cushioning and Voidfill . . . . .	64		

## G

Gas Cylinder Trolley . . . . .	105	Glue Gun Adhesives . . . . .	133	Gusseted Paper Sacks . . . . .	28
Geami WrapPak® . . . . .	68	Grip Seal Bags . . . . .	24 - 25		
Glue Guns . . . . .	133	Gummed Paper Tapes and Dispenser . . . . .	93		

## H

Hand-Applied Corded Polyester Strapping . . . . .	153	Hand Towels . . . . .	109	Hazard Tape . . . . .	121
Hand-Applied Polyester Strapping . . . . .	152	Hand Strapping Starter Kit . . . . .	148	Heat Sealers . . . . .	129
Hand Applied Strapping . . . . .	148	Handywrap Applicator Handle . . . . .	142	Hydro-Freeze Ice Packs . . . . .	34
Hand Applied Stretch Films . . . . .	140	Handywrap Mini Reel . . . . .	142		
Hand-Held Tape Dispenser . . . . .	124	Handywrap Starter Kit . . . . .	142		

## I

I.B.® Flex™ . . . . .	54	Inka Presswood Pallets . . . . .	17	Instapak® Quick RT Starter Kit . . . . .	67
Ice sheets . . . . .	19	Instapak FoamWrap™ Express . . . . .	64	Instapak® Simple™ . . . . .	64
Industrial Shelving . . . . .	128	Instapak iMold™ . . . . .	63	Instapacker® Tabletop . . . . .	65
Imitation Kraft Paper . . . . .	62	Instapak® Quick RT . . . . .	66		
Impulse Heat Sealer . . . . .	101	Instapak® Quick Tuff® RT® . . . . .	66		

## K

Knives . . . . .	132	Korrvu® Retention Packaging . . . . .	57	Korrvu® Suspension Packaging . . . . .	59
Korrvu® Bottle packs . . . . .	59	Korrvu® Select . . . . .	57	Kraft Papers . . . . .	81

## L

Layflat Polythene Tubing . . . . .	100	Loosefill Packing Chips . . . . .	74	Low Noise Packing Tapes . . . . .	89
LDPE Shrink Film . . . . .	103	Loosefill Dispenser and Frame . . . . .	75		

## M

Machine Applied Stretch Film . . . . .	113	Mail Lite® Plus . . . . .	31	Mesh Sleeving . . . . .	75
Machine Applied Tapes . . . . .	97	Mail Lite® White & Gold . . . . .	30	Mini Pak'R™ and Air Cushions . . . . .	60
Machine Pallet Wrap . . . . .	114	Mail Lite® Padded Mailers. . . . .	32	Mini Wrap . . . . .	112
Machine Pre-stretch Film . . . . .	113	Mail Lite Tuff® . . . . .	31	Mobile Phone Postal Pack . . . . .	50
Magneta Heat Sealers. . . . .	101	Mailing Sacks . . . . .	31		
Mailing Bags . . . . .	33	Masking Tape . . . . .	92		

## N

Netting. . . . .	75	Newsprint Off-Cuts . . . . .	84
------------------	----	------------------------------	----

## O

Oscillated Steel Strapping. . . . .	125	Overlap Seals . . . . .	125	Oyster Packs . . . . .	39
-------------------------------------	-----	-------------------------	-----	------------------------	----

## P

Packing Chips . . . . .	74	Paper Mailing Bags . . . . .	34	Postal Boxes . . . . .	38
Packing Knives . . . . .	132	Paper Roll . . . . .	81	Postal Envelopes. . . . .	35
Packing Openers. . . . .	132	Paper Sacks. . . . .	28	<b>Postal Section . . . . .</b>	<b>29</b>
Packing Stations. . . . .	130	<b>Paper Section . . . . .</b>	<b>79</b>	Postal Tubes . . . . .	36
Packing Stations Sack . . . . .	131	Paper Tapes. . . . .	93	Postal Wraps. . . . .	35
Packing Tapes . . . . .	89	PC Component Packs . . . . .	40	Power Pre Stretch Films. . . . .	113
Padded Mailers. . . . .	32	Pelaspán® Bio Loosefill . . . . .	74	Pre-Stretched Films . . . . .	111
PadPak CC™ . . . . .	71	Plastic Bags. . . . .	28	Premium PVC Tapes . . . . .	91
PadPak® Junior . . . . .	72	Plastic Corner Protectors . . . . .	76	Presswood Pallets . . . . .	17
PadPak LC™ . . . . .	71	Plastic Pallets . . . . .	17	Printed Warning Tapes. . . . .	95
PadPak LC™ Plus . . . . .	71	Polyester Strapping . . . . .	122	ProPak'R™ . . . . .	61
PadPak® Senior. . . . .	72	Polyolefin Shrink Film . . . . .	132	<b>Protective Section . . . . .</b>	<b>43</b>
Painters Tapes. . . . .	92	Polypropylene Strapping . . . . .	118	Protective Sheeting . . . . .	102
Pallet Boxes. . . . .	16	Polypropylene Tapes . . . . .	89	PVC Shrink Film. . . . .	132
Pallet Top Sheets . . . . .	102	Polystyrene Chips. . . . .	74	PVC Tapes . . . . .	91
Pallet Wrap . . . . .	103	Polythene Bags . . . . .	22		
Palletised Containers . . . . .	16	Polythene Carrier Bags . . . . .	28		
Pallets . . . . .	17	Polythene Cutters. . . . .	132		
Paper Bags . . . . .	27	Polythene Postal Bags . . . . .	33		
Paper Bubble Wrap . . . . .	80	<b>Polythene Section . . . . .</b>	<b>99</b>		
Paper Cushioning and Voidfill . . . . .	69	Polythene Centrefold Shrinkable Film . . . . .	103		
Paper Document Wallets . . . . .	34	Polythene Sheeting . . . . .	102		
Paper packing sheets . . . . .	84	Polythene Shrink Film. . . . .	103		
Paper Postal Bags. . . . .	34	Polythene Tubing . . . . .	100		



R

Racking .....	128	Ranpak® Padpak® JR .....	72	Retractable Packing Knife .....	132
Racking Labels .....	129	Ranpak® Padpak® LC™ .....	71	Ribbed Kraft Paper .....	81
Rack Sacks .....	131	Ranpak® Padpak® LC plus™ .....	71	Ribbon Wound Steel Strapping .....	124
Ranpak® FillPak® .....	70	Ranpak® Padpak® Paper .....	72	Rotoplat 508PDS Stretch Wrapping Machine .....	115
Ranpak® Fillpak® Fanfold Paper .....	70	Ranpak® PadPak® Senior .....	72	Robot Master PDS Power-Pre Stretch Wrapping Machine .....	115
Ranpak® FillPak M™ .....	69	Ranpak® WrapPak .....	73	Rubbish Bags .....	26
Ranpak® FillPak TT® .....	69	Recycling Refuse Sacks .....	26	Rubble Sacks .....	26
Ranpak® FillPak TT with Cutter® .....	69	RecycoolMe .....	18		
Ranpak® Fillpak® SL .....	69	Refuse Sacks .....	26		
Ranpak® Geami WrapPak® .....	68	Reinforced Tapes .....	96		
Ranpak® PadPak CC™ .....	71	Retention Packaging .....	57		

S

ScreenGuard Foam Protection .....	77	Sealed Air® Mail Tuff® .....	33	Storopack Loosefill Packing Chips .....	74
Sealed Air® AirCap® Anti-Static Barrier Sealed Bubble Cushioning Wrap .....	46	Sealed Air® Mailing Bags .....	33	Storopack Pelapan Bio Loosefill .....	74
Sealed Air® AirCap® Bubble Wrap .....	44	Sealed Air® SpeedyPacker® Insight™ .....	63	Storopack Loosefill Dispenser and Frame .....	75
Sealed Air® AirCap® Bubble Bags .....	47	Seals .....	120	Strapping .....	118
Sealed Air® AirCap® Bubble Guard .....	48	Self-Adhesive Bubble Wrap .....	48	Strapping Cutters .....	121
Sealed Air® AirCap® BubbleMask™ .....	48	Self Adhesive Paper Tape .....	92	Strapping Dispensers and Trolleys .....	118
Sealed Air® I.B.® FlexTM Film .....	54	Shelf Labels and Card Inserts .....	129	Strapping Buckles .....	120
Sealed Air® Cell-Aire® Polyethylene Foam .....	62	Shell Packs .....	39	Strapping Seals .....	120
Sealed Air® Fill-Air® RF .....	66	Shelving .....	128	<b>Strapping Section .....</b>	<b>117</b>
Sealed Air® Fill-Air Rocket .....	56	Shelving Bay Connectors .....	128	Strapping Tools .....	121
Sealed Air® Instapak FoamWrap™ Express .....	66	Shockwatch .....	130	Stretch Film Dispensers .....	112
Sealed Air® Instapak iMold™ .....	63	Shopping Bags .....	27	Stretch Films .....	113
Sealed Air® Instapak® Quick RT .....	66	Shrink Film Guns .....	105	<b>Stretch Section .....</b>	<b>107</b>
Sealed Air® Instapak® Quick Tuff® RT® .....	67	Shrink Wrap .....	103	Stretch Wrapping Machines .....	114
Sealed Air® Instapak® Quick RT Starter Kit .....	67	Shrink Wrap Films .....	103	Suspension Packaging .....	59
Sealed Air Instapak® Simple™ .....	64	Shrink Wrap Pallet Covers .....	103		
Sealed Air® Instapacker® Tabletop .....	55	Shrinkable Film .....	103		
Sealed Air® Korrvu® Bottle Pack .....	59	Single Faced Corrugate Paper .....	80		
Sealed Air® Korrvu® Mobile Phone, Tablet & Laptop Postal Packs .....	57	Single Wall Boxes .....	12		
Sealed Air® Korrvu® Retention Box .....	58	Snap On Seals .....	124		
Sealed Air® Korrvu® Retention Frame .....	57	Solid Board Folding Cartons .....	38		
Sealed Air® Korrvu® Suspension .....	59	Sorbatek .....	20		
Sealed Air® Mail Lite® Plus .....	31	SpeedyPacker® Insight™ .....	63		
Sealed Air® Mail Lite® White & Gold .....	30	ST-IMAG Combination Tool .....	126		
Sealed Air® Mail Lite® Padded Mailers .....	32	Standard Polypropylene Tapes .....	90		
Sealed Air® Mail Lite® Tuff .....	31	Steel Strapping .....	124		
		Steel Strapping Tools and Accessories .....	125		

T

Tablet Postal Pack.....	50	Tape Dispenser.....	98	Tissue Paper.....	85
Tamper Evident Tapes.....	96	<b>Tapes Section.....</b>	<b>87</b>	Trolleys.....	119

U

Unlined Postal Boxes.....	38
---------------------------	----

V

Value Polypropylene Tapes.....	89	Vinyl Tapes.....	91	Vermiculite.....	78
VCI Polythene.....	104	VCI Kraft Paper.....	83		

W

Warning Tapes.....	95	Woodwool.....	78
Waxed Kraft Paper Roll.....	82	Wrapping Machines.....	114
Wine Bottle Boxes.....	40	Write-on Panels Medium Duty Grip Seal Bags.....	.24





Macfarlane Packaging provides protective packaging products and services to businesses throughout the UK, Ireland and Continental Europe.

## SOUTH EAST

### Aylesbury

Tel: 01296 652 700

Email: sales@ecopac.co.uk

### Fareham

Tel: 01329 854 300

Email: fareham@macfarlanepackaging.com

### Harlow

Tel: 0844 770 1409

Email: harlowsales@macfarlanepackaging.com

### Horsham

Tel: 01403 825 600

Email: horsham@macfarlanepackaging.com

### Sudbury

Tel: 01787 315 000

Email: sudbury@macfarlanepackaging.com

## SOUTH WEST

### Bristol

Tel: 0117 317 2660

Email: bristol@macfarlanepackaging.com

### Exeter

Tel: 01392 825 300

Email: exeter@macfarlanepackaging.com

### Gloucester

Tel: 01452 555 550

Email: gloucester@macfarlanepackaging.com

### Plymouth

Tel: 01752 967 222

Email: plymouth@macfarlanepackaging.com

### Reading

Tel: 0118 944 2425

Email: readingsales@macfarlanepackaging.com

## MIDLANDS

### Coventry

Tel: 02476 217 000

Email: coventry@macfarlanepackaging.com

### East Midlands

Tel: 01476 513 602

Email: grantham@macfarlanepackaging.com

### Milton Keynes

Tel: 01908 512 900

Email: miltonkeynes@macfarlanepackaging.com

### Wolverhampton

Network Packaging Ltd

Tel: 01902 496 666

Email: sales@networkpack.co.uk

## NORTH EAST

### Newcastle

Tel: 0191 229 5550

Email: newcastle@macfarlanepackaging.com

### Teesside

Tel: 01642 877 177

Email: teessidesales@macfarlanepackaging.com

### Wakefield

Tel: 01924 874 700

Email: wakefieldsales@macfarlanepackaging.com

## NORTH WEST

### Heywood

Tel: 0161 872 5200

Email: nwdcsales@macfarlanepackaging.com

### Leyland

Tel: 01772 331780

Email: leylandsales@macfarlanepackaging.com

## SCOTLAND / IRELAND

### Glasgow

Tel: 0141 840 2000

Email: glasgowsales@macfarlanepackaging.com

### Inverness

Tel: 0141 333 9666

Email: glasgow@macfarlanepackaging.com

### Macfarlane Ireland

Tel: 0818 3000 68

Email: salesie@macfarlanepackaging.ie

## MACFARLANE CONTINENTAL EUROPE

Tel: +31 23 7996888

Email: accounts@macfarlanepackaging.com



# Macfarlane Packaging protects...

...your ESG commitments

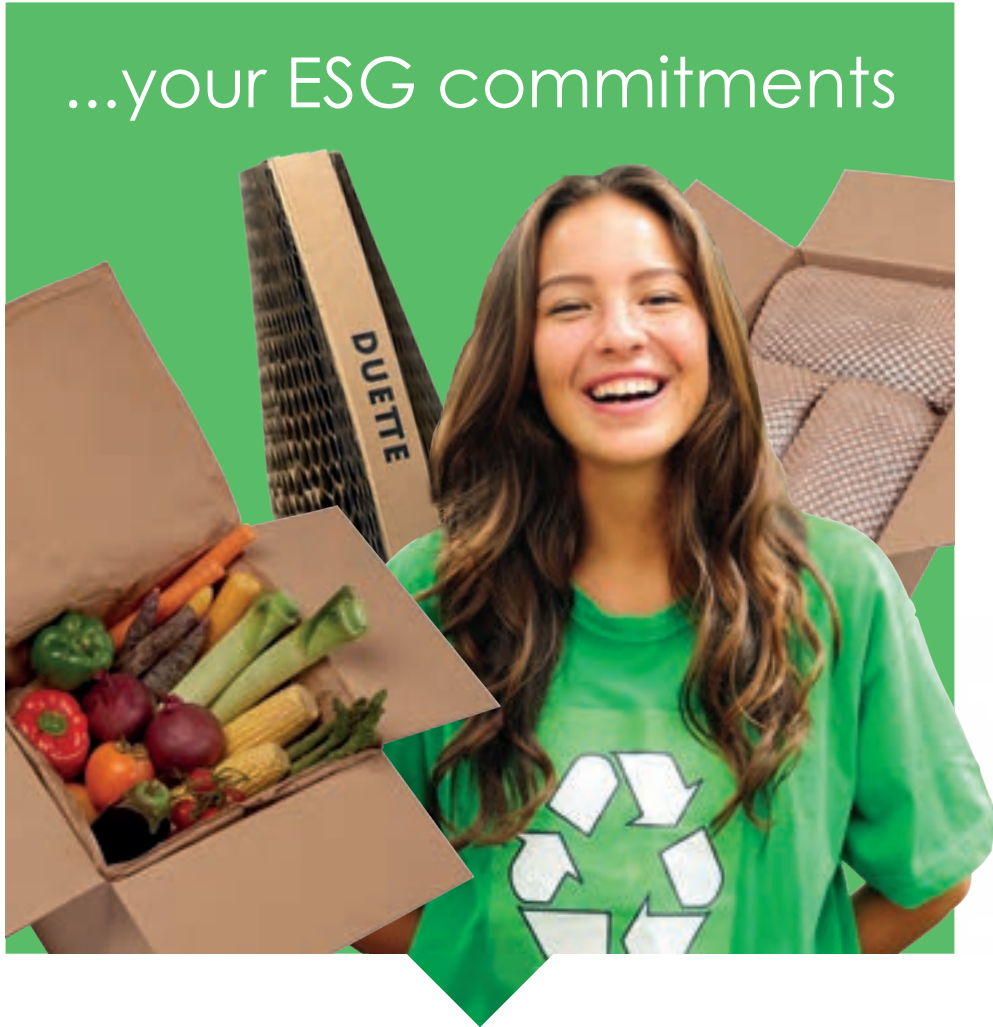

Our wide range of sustainable packaging products and solutions help reduce the environmental impact of your business. This helps you meet your ESG commitments and, increasingly, it's what your customers demand.

## What will you protect?



reachmarketing.co.uk 35428 02/23



macfarlanepackaging.com